

infactory

Sensores Sinequanon
Sinequanon sensors

Dispensadores de papel y jabón
Paper and soap dispensers

Vestuario
Professional clothing

Higiene y Seguridad alimentaria
Hygiene and food safety



www.moldnpack.com



imfactory

Im factory nace en 1997 de la experiencia internacional de sus miembros en la fabricación de dispensadores de papel y jabón, vestuario profesional, trampas para insectos voladores, secamanos eléctricos y transformación de papel para el mercado “away from home”.

Innovamos escuchando a nuestros clientes y buscando aquellos pequeños cambios que puedan suponer mejoras tanto en eficiencia como en seguridad, respondiendo con productos nuevos, lo que a día de hoy nos permite presentarles un amplio Catálogo, diferenciado y muy valorado por los usuarios de industrias tan importantes como la alimentaria, horeca, educativa, médico-hospitalaria e industria y colectividades en general.

Ser parte de un grupo internacional con fábricas en USA y Vietnam, nos garantiza esa visión global del sector tan necesaria hoy en día así como unos servicios de Ingeniería de primer nivel y una dedicada atención al cliente.

Im factory was born in 1997 from the international experience of its members in the manufacture of paper and soap dispensers, professional clothing, flying insect traps, electric hand dryers and paper converting for the “away from home” market.

We innovate by listening to our customers and looking for those small changes that can lead to improvements in efficiency and security, responding with new products, which today allows us to introduce you with a wide catalog, differentiated and highly valued by users of industries as important as food , horeca, educational, medical- Hospital and industry and collectivities in general.

Being part of an international group with factories in the USA and Vietnam, guarantees that global vision of the industry so necessary today as well as first class engineering services and dedicated customer service.

mfactory

ALWIN
www.alwin.com



Dispensadores de Papel y Jabón <i>Paper and soap dispensers</i>	PullNap	8	
	SineQuaNon	10	
	Dispensadores de Papel.....	13	
	Paper dispensers		
	Dispensadores de Jabón	22	
	Soap dispensers		
	Dermex.....	26	
	Sani Suds	28	
	Vestuario laboral <i>Professional clothing</i>	Carta de colores, telas y tallaje	31
		Color chart, fabric options and size	
Casullas.....		32	
Cobbler aprons			
Delantales.....		35	
Aprons			
Guantes		38	
Gloves			
Batas		40	
Lab coats			
Chalecos		44	
Vest jackets			
Pijamas		45	
Scrubs			
Indumentaria chef		47	
Chef apparel			
Gorras, cofias y capuces		50	
Caps, hair nets and hoods			
Ropa de trabajo.....	54		
Workwear			
Higiene, y seguridad alimentaria <i>Hygiene and food safety.</i>	Matainsectos	58	
	Fly-insect traps		
	Secamanos.....	63	
	Hand dryers		
	Secapelos.....	67	
	Hair dryer		
Rejillas urinarios	68		
Urinal screens			





PullNap

Centerpull Napkin

PullNap es la marca de un diseño industrial registrado ante la Oficina Española de Patentes y Marcas (OEPM) con registro N°0530718 como "Dispensador de servilletas sobremesa, personalizable por extracción central".

PullNap is a brand name of a registered industrial design in the Spanish office of patents and brands (Oficina Española de Patentes y Marcas (OEPM)) registered with the N°0530718 as a "Tabletop centerpull Napkin Dispenser".



Dispensador de servilletas sobremesa personalizable por extracción central

Tabletop centerpull Napkin Dispenser

Mayor capacidad que los sistemas actuales (450 servicios frente a los 60 – 100 habituales)
 Greater capacity than current systems (450 services compared to the usual 60 – 100).

Permite la publicidad de menús, número de mesa, acontecimientos de temporada como: Navidad, Verano, San Valentín, etc... a través de plantillas personalizables ubicadas en la web.
 It allows the advertising of menus, table number, seasonal events such as: Independence day, Christmas, Summer, Valentine's Day, Thanksgiving day, Halloween etc... through customizable templates placed in the web.

Apto para el lavavajillas, garantizando su higiene periódica.
 Dishwasher safe, guaranteeing its periodic hygiene.

Papel de mayor absorción.
 Greater absorption of the paper.

Alta durabilidad del dispensador, ya que está fabricado en PC (policarbonato), siendo prácticamente irrompible y aditivado con anti UV para demorar el envejecimiento por exposición al sol.
 High durability of the dispenser, as it is made of PC (polycarbonate), being practically unbreakable and additivated with anti UV to delay aging by sun exposure.

Son apilables, facilitando su recogida diaria.
 They are stackable, facilitating their daily collection.

Sistema muy económico.
 It is a very cost effective system.



PULLNAP

Dispensador de servilletas de extracción central para sobremesa
 Policarbonato transparente y base de polipropileno blanco

Tabletop centerpull napkin dispenser
 Transparent polycarbonate and white polypropylene base

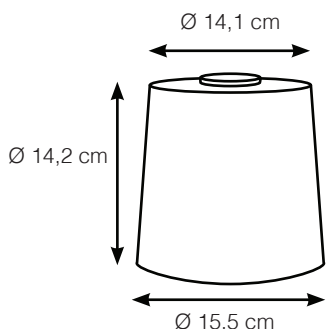

Especificaciones técnicas
Technical specifications:

Unidades por caja Units per box	15 unidades 15 units
------------------------------------	-------------------------

Unidades x pallet Units per pallet	840 unidades 840 units
---------------------------------------	---------------------------

Longitud x servicio Sheet length	21 cm
-------------------------------------	-------

Servicios por rollo N° services	450 servicios 450 services
------------------------------------	-------------------------------

¿Qué necesitas para imprimir?

Papel Din A4
 Una impresora
 Acoplar las imágenes deseadas a las siguientes plantillas.

What do you need to print?

A4 or letter size paper
 A printer
 Bind the images you desire with the following templates.

Plantillas para personalizar tu PullNap
 Templates to customize your PullNap



Plantilla 1
 Template 1



Plantilla 2
 Template 2

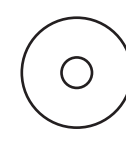

Plantilla 3
 Template 3

Ideal para su funcionamiento con la referencia EC44400P, rollo de celulosa pura de alta calidad. Pack de 18 rollos con 450 servicios por rollo de 13 x 20 cm.

Specially designed for operating with the reference EC44400P, pure cellulose roll high quality. Pack of 18 rolls with 450 services per roll of 13 x 20 cm.

Ideal para su funcionamiento con la referencia EC44350N, rollo de celulosa natural de alta calidad. Pack de 18 rollos con 400 servicios por rollo de 13 x 20 cm.

Specially designed for operating with the reference EC44350N, natural cellulose roll high quality. Pack of 18 rolls with 400 services per roll of 13 x 20 cm.



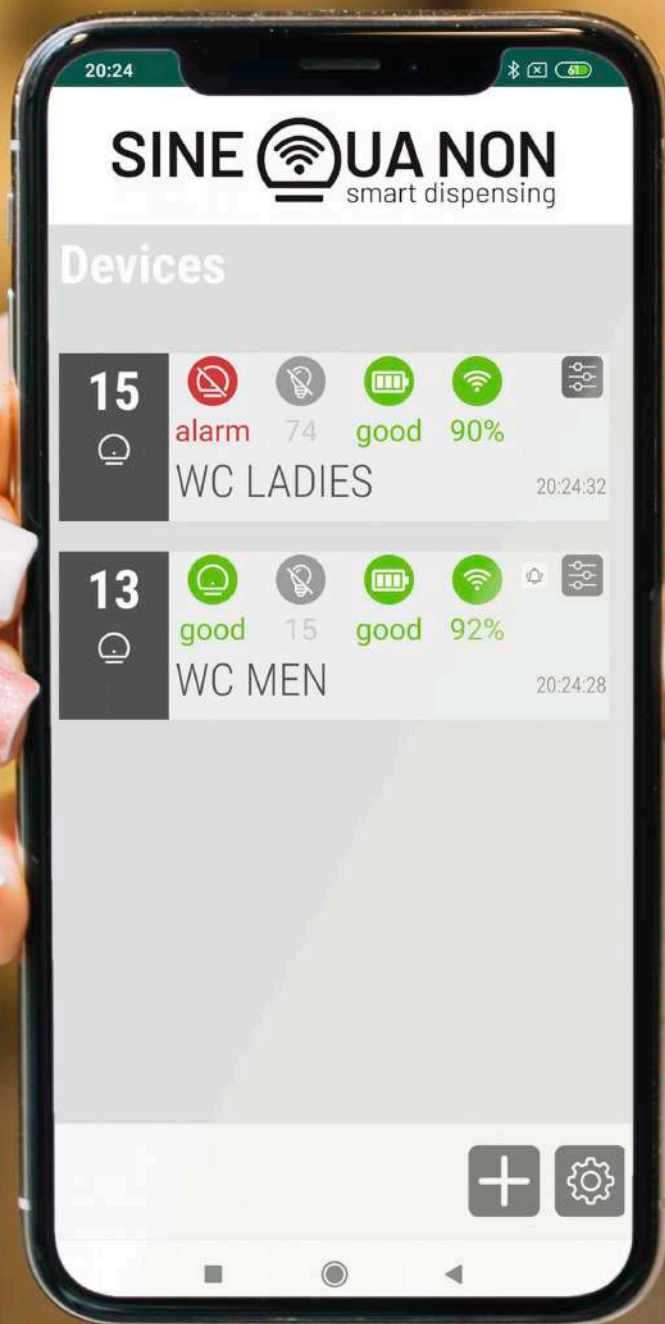

SineQuaNon: Sistema de monitoreo de niveles de papel

// Sinequanon: Monitoring system of paper levels



SNQN App
SNQN App

Sinequanon, es un sistema inalámbrico universal basado en un conjunto de sensores e indicadores, diseñado para monitorear el nivel de papel, avisando de aquellas situaciones en las que es urgente la reposición del consumible.

Sinequanon is a universal wireless system based on a set of sensors and indicators, designed to monitor the level of paper, notifying of those situations in which the replacement of the consumable is needed urgently.

El sistema consta de los siguientes componentes: The system consists of the following components:

- Sensores SNQN, que emiten la información relativa a niveles de papel.
• SNQN sensors, which emit information related to levels of paper.
- Indicador SNQN, recibe la información de todos los sensores e indica el estado general de la instalación mediante led, verde ó rojo.
• SNQN indicator, receives the information from all the sensors and indicates the general status of the installation by means of a green or red LED.
- SNQN App, la cual permite dar de alta los sensores, presentando la información conjunta de forma sencilla e intuitiva y generando diferentes tipos de alarma.
• SNQN App, which allows to register the sensors, presenting the joint information in a simple and intuitive way and generating different types of alarms.

Sinequanon es un sistema innovador de fácil instalación, sin cuotas mensuales de mantenimiento y con carácter universal.

Su objetivo es garantizar que en los baños públicos de un restaurante, tienda, oficina, fábrica, consultorio médico, academia, gasolinera, etc... se dispone del nivel adecuado de papel, mejorando la experiencia de clientes, empleados y usuarios, evitando al mismo tiempo la utilización de papel para el secado de las manos como higiénico y con ello previniendo la posible obstrucción de tuberías y desagües.

Sinequanon is an innovative system that is easy to install, with no monthly maintenance fees and is universal.

Its objective is to guarantee that in the public toilets of a restaurant, shop, office, factory, doctor's office, academy, gas station, etc... the adequate level of paper is available, improving the experience of clients, employees and users, avoiding at the same time the use of paper for drying hands as a hygienic and preventing as a consequence the obstruction of pipes and drains.

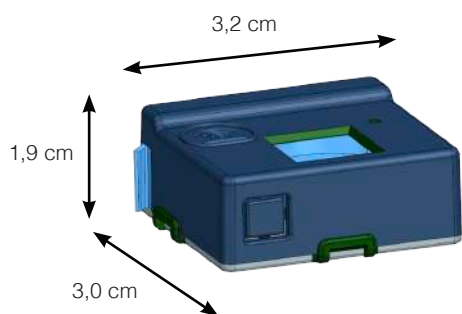

SNQN Sensor01

Detecta el nivel de papel y comunica de forma inalámbrica.
Polipropileno negro.

Detects the level of paper and transmits wireless.
Black Polypropilene.

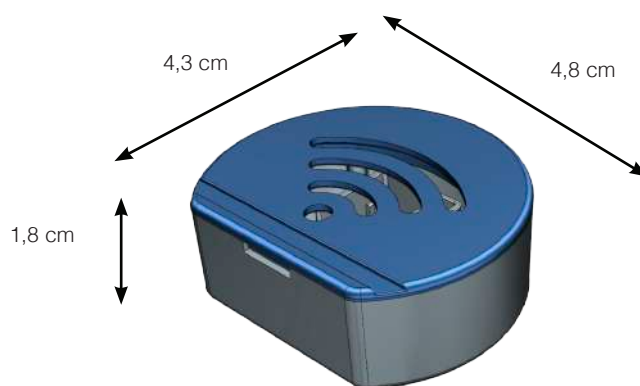

SNQN Indicador01

Recibe la información de los sensores e indica el estado general de la instalación.
Polipropileno translúcido.

Receives the information from the sensors and indicates the general status of the installation.
Translucent polypropilene.



Dispensadores de Papel y Jabón

Paper and Soap dispensers

Dispensadores de Papel
Paper dispensers

Dispensadores de Jabón
Soap dispensers

Dermex

Sani Suds

Dispensadores de toalla en rollo con mecanismo autocorte

Roll towel dispensers with autocut mechanism (MHF)



Sin baterías, de tracción manual.
No batteries, manual traction.

Intuitivo e higiénico, no hay que tocar el dispensador, sólo el trozo de papel
Intuitive and hygienic, there is no need to touch the dispenser, only the paper.

Ahorra hasta un 30% del papel frente a los sistemas de toalla plegada.
Saves up to 30% of paper against the folded towel systems.

Cubierta translúcida para facilitar la visión del papel.
Translucent cover to see the paper level.

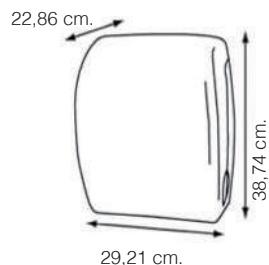

TD20103

Dispensador autocorte blanco

Cubierta blanca translúcida, cuerpo blanco

Autocut dispenser, white

White translucent cover and solid white body.

TD20102

Dispensador autocorte negro

Cubierta fumé translúcida, cuerpo negro

Autocut dispenser, black

Smoked translucent cover and solid black body

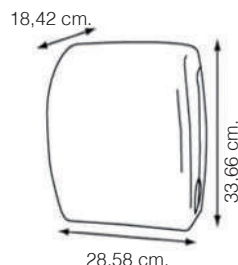

TD20203

Dispensador mini autocorte blanco

Cubierta blanca translúcida, cuerpo blanco

Autocut mini dispenser, white

White translucent cover and solid white body

TD20202

Dispensador mini autocorte negro

Cubierta fumé translúcida, cuerpo negro

Autocut mini dispenser, black

Smoked translucent cover and solid black body

Especificaciones técnicas / Technical specifications:

Capacidad Capacity	Rollo de toalla de 20-21 cm. de Ø y 20-21 cm de ancho 20-21 cm Ø and 20-21 cm wide roll towel
Ø del canuto Ø core	40 mm.
Unidades x pallet Units per pallet	65 unidades envasadas individualmente 65 units individually packaged
Longitud x servicio Sheet length	27 cm.
Tipo de papel Type of paper	Sin precorte, una capa con fuerte resistencia longitu- dinal y poco crepado No perforation, strong longitudinal resistance and low stretch

Especificaciones técnicas / Technical specifications:

Capacidad Capacity	Rollo de toalla de 15-16 cm. de Ø y 20-21 cm de ancho 15-16 cm Ø and 20-21 cm wide roll towel
Ø del canuto Ø core	40 mm.
Unidades x pallet Units per pallet	96 unidades envasadas individualmente 96 units individually packaged
Longitud x servicio Sheet length	27 cm.
Tipo de papel Type of paper	Sin precorte, una capa con fuerte resistencia longitu- dinal y poco crepado No perforation, strong longitudinal resistance and low stretch



BAS007WH

Dispensador autocorte blanco Dropline

ABS Cubierta blanca, cuerpo gris

Autocut dispenser, white Dropline

ABS White cover and solid grey body

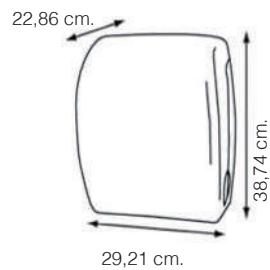

BAS007BK

Dispensador autocorte negro Dropline

ABS acabado negro con tacto de goma, soft

Autocut dispenser, black Dropline

ABS black finished with rubber touch, soft

BAS007CHR

Dispensador autocorte plateado Dropline

ABS acabado metalizado

Autocut dispenser, Silver Painted Dropline

ABS silver painted

Especificaciones técnicas / Technical specifications:

Capacidad Capacity	Rollo de toalla de 20-21 cm. de Ø y 20-21 cm de ancho 20-21 cm Ø and 20-21 cm wide roll towel
Ø del canuto Ø core	40 mm.
Unidades x pallet Units per pallet	65 unidades envasadas individualmente 65 units individually packaged
Longitud x servicio Sheet length	27 cm.
Tipo de papel Type of paper	Sin precorte, una capa con fuerte resistencia longitudinal y poco crepado No perforation, strong longitudinal resistance and low stretch



Dispensadores electrónicos de toalla en rollo

Electronic sensor roll towel dispensers



Larga vida de las baterías, comprobados hasta 72.000 servicios (100 diarios x 2 años).
Batteries long life, tested up to 72.000 uses (100 per day during 2 years).

Universal, al funcionar electrónicamente, trabaja con todos los tipos de papel sin precorte.
Universal, it works with all kinds of non perforated paper.

Intuitivo e higiénico, no hay que tocar el dispensador, solo el trozo de papel.
Intuitive and hygienic, no need to touch the dispenser, only the paper.

Rollo de reserva, para aprovechar el papel al 100%.
Stub roll to use 100% of the paper.

Cubierta translúcida para facilitar la visión del papel.
Translucent cover to see the paper level.

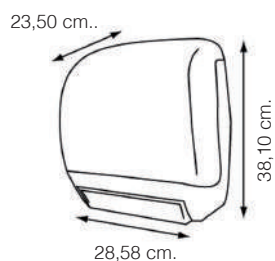

TD24503

Dispensador electrónico Premium blanco
 Cubierta blanca translúcida, cuerpo blanco

Premium Electronic dispenser, white
 White translucent cover, solid white body

TD24502

Dispensador electrónico Premium negro
 Cubierta fumé translúcida, cuerpo negro

Premium Electronic dispenser, black
 Smoked translucent cover, solid black body

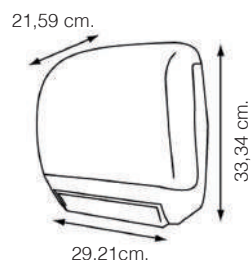

TD23503

Dispensador electrónico blanco
 Cubierta blanca translúcida, cuerpo blanco

Electronic dispenser, white
 Translucent white cover, solid white body

TD23502

Dispensador electrónico negro
 Cubierta fumé translúcida, cuerpo negro

Electronic dispenser, black
 Smoked translucent cover, solid black body

Especificaciones técnicas / Technical specifications:

Capacidad Capacity	Rollo de toalla de 20,32 cm. de Ø y 20,32 cm de ancho 20,32 cm. de Ø and 20,32 cm wide roll towel
Ø del canuto Ø core	40 mm.
Unidades x pallet Units per pallet	55 unidades envasadas individualmente 55 units individually packaged
Longitud x servicio Sheet length	Tres medidas 22, 30 y 38 cm. Three measures: 22, 30 and 38 cm.
Delay	Tiempo de espera entre servicios 0, 1, ó 2 segundos 0, 1 or 2 seconds delay
Modo ahorro de papel Saving paper mode	Segundo servicio puede ser hasta un 25% más corto si lo pedimos antes de 2 segundos Second service could be up to 25% shorter if you demand it in less than 2 seconds respect the first
Rollo de reserva Stub roll	Sí, con mecanismo de transferencia automática para aprovechar el papel al 100% Yes, with automatic transfer arm in order to use the 100% of the paper.

Especificaciones técnicas / Technical specifications::

Capacidad Capacity	Rollo de toalla de 20,32 cm. de Ø y 20,32 de ancho 20,32 cm. de Ø and 20,32 cm wide roll towel
Ø del canuto Ø core	40 mm.
Unidades x pallet Units per pallet	78 unidades envasadas individualmente 78 units individually packaged
Longitud x servicio Sheet length	27 cm.
Rollo de reserva Stub roll	Sí, con bandeja posterior Yes, with an inside down tray

**TD23403****Dispensador mini electrónico blanco**

Cubierta blanca translúcida, cuerpo blanco

Autocut mini dispenser, white

White translucent cover, solid white body

TD23402**Dispensador mini electrónico negro**

Cubierta fumé translúcida, cuerpo negro

Autocut mini dispenser, black

Smoked translucent cover, solid black body

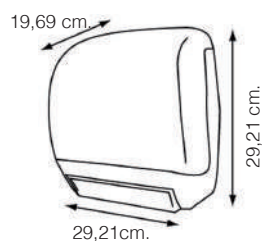
*Especificaciones técnicas / Technical specifications:*

Capacidad Capacity	Rollo de toalla de 16,5 cm. de Ø y 20-21 de ancho 15-16 cm Ø and 20-21 cm wide roll towel
Ø del canuto Ø core	40 mm.
Unidades x pallet Units per pallet	72 unidades envasadas individualmente 72 units individually packaged
Longitud x servicio Sheet length	27 cm.
Rollo de reserva Stub roll	Sí, con bandeja posterior Yes, with an inside down tray



Dispensadores de toalla con palanca

Lever roll towel dispensers



Universal, al funcionar mecánicamente a través de la palanca.
Universal, it works mechanically through the lever.

Intuitivo e higiénico, al no haber necesidad de tocar el dispensador con las manos. Sólo impulsando la palanca con el antebrazo, muñeca o codo.
Intuitive and hygienic, hands free dispenser. Only by pushing the lever with the forearm, wrist or elbow.

Sin baterías, de tracción manual.
No batteries, manual traction.

Cubierta translúcida para facilitar la visión del papel.
Translucent cover to see the paper level.



TD22003

Dispensador palanca blanco

Cubierta blanca translúcida, cuerpo blanco

White lever dispenser

White translucent cover, solid white body

TD22002

Dispensador palanca negro

Cubierta fumé translúcida, cuerpo negro

Black lever dispenser

Smoked translucent cover, solid black body

Especificaciones técnicas / Technical specifications:

Capacidad Capacity	Rollo de toalla de 20,32 cm. de Ø y 20,32 de ancho 20,32 cm. de Ø and 20,32 cm wide roll towel
Ø del canuto Ø core	40 mm.
Unidades x pallet Units per pallet	78 unidades envasadas individualmente 78 units individually packaged
Longitud x servicio Sheet length	Dos medidas 10 y 13 cm. Two measures: 10 and 13 cm.
Rollo de reserva Stub roll	Sí, con bandeja posterior Yes, with an inside down tray

Extensión
higiénica
de la palanca
Hygienic
lever
extension

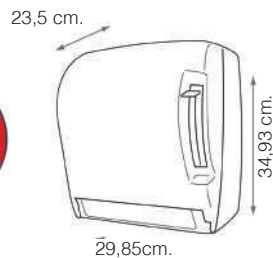

Dispensador de toalla mecha // Center pull roll towel dispenser



TD025502

Dispensador Alwin autoajustable

Cubierta fumé traslúcida, cuerpo negro
26x26x31 cm

Rollo altura máxima 22,8 x Ø22,8 cm
autoajustable a la salida del papel
proporcionando servicios hoja a hoja.

Autoadjustable center pull dispenser

Smoked translucent cover, black body
26x26x31 cm

Max. height 22,8x Ø22,8 cm
autoadjustable to deliver sheet by sheet.



ESS200WH

Dispensador mecha Esencial

ABS blanco 23,7 x 23,7 x 38 cm.
Rollo altura máxima 25,5 x Ø21 cm

Center pull roll dispenser Esencial

White ABS 23,7 x 23,7 x 38 cm.
Max. height 25,5 x Ø21 cm

**BAS004BK**

Dispensador mecha Dropline
ABS acabado negro con tacto de goma, soft
32,1 x 22 x 20,7 cm.
Rollo altura máxima 24 x Ø 19 cm

Centerpull Dropline dispenser
ABS black finished with rubber touch, soft
32,1 x 22 x 20,7 cm.
Max. roll height 24 x Ø 19 cm

NEW**BAS004WH**

Dispensador mecha Dropline
ABS acabado blanco y cuerpo gris
32,1 x 22 x 20,7 cm.
Rollo altura máxima 24 x Ø 19 cm

Centerpull Dropline dispenser
ABS white finished and grey body
32,1 x 22 x 20,7 cm.
Max. roll height 24 x Ø 19 cm

NEW**BAS004CHR**

Dispensador mecha Dropline
ABS acabado metalizado
32,1 x 22 x 20,7 cm.
Rollo altura máxima 24 x Ø 19 cm

Centerpull Dropline dispenser
ABS silver painted
32,1 x 22 x 20,7 cm.
Max. roll height 24 x Ø 19 cm

NEW

Dispensador de toalla mini mecha // Mini center pull roll towel dispenser

**BAS006BK**

Dispensador mecha Dropline
ABS acabado negro con tacto de goma, soft
28,05 x 15 x 14 cm.
Rollo altura máxima 21,5 x Ø 12,5 cm

Centerpull Dropline dispenser
ABS black finished with rubber touch, soft
28,05 x 15 x 14 cm.
Max. roll height 21,5 x Ø 12,5 cm

NEW**BAS006WH**

Dispensador mecha Dropline
ABS acabado blanco y cuerpo gris
28,05 x 15 x 14 cm.
Rollo altura máxima 21,5 x Ø 12,5 cm

Centerpull Dropline dispenser
ABS white finished and grey body
28,05 x 15 x 14 cm.
Max. roll height 21,5 x Ø 12,5 cm

NEW**BAS006CHR**

Dispensador mecha Dropline
ABS acabado metalizado
28,05 x 15 x 14 cm.
Rollo altura máxima 21,5 x Ø 12,5 cm

Centerpull Dropline dispenser
ABS silver painted
28,05 x 15 x 14 cm.
Max. roll height 21,5 x Ø 12,5 cm

NEW

Higiénico // Toilet tissue JBT



RD032102

Portarrollos Alwin mini Twin

Cubierta fumé traslúcida, cuerpo negro
29,8 x 14 x 17,8 cm
Con mecanismo de aprovechamiento 100%
Rollo Ø max. 135 x Ø canuto 40 mm.

JBT Alwin mini Twin dispenser

Smoked translucent cover, black body
29,8 x 14 x 17,8 cm
With mechanism to use 100% of the paper
Ø max. 135 x Ø canuto 40 mm core roll.



RD02702

Portarrollos Alwin Twin

Cubierta fumé traslúcida, cuerpo negro
51,4 x 14 x 29,8 cm
Con mecanismo de aprovechamiento 100%
Rollo Ø max. 228 x Ø canuto 60 mm.

JBT Alwin Twin dispenser

Smoked translucent cover, black body
51,4 x 14 x 29,8 cm
With mechanism to use 100% of the paper
Ø max. 228 x Ø 60 mm. core roll



ESS100WH

Dispensador higiénico Essencial

ABS blanco 26,5 x 12 x 26 cm.
Rollo Ø max. 230 x Ø canuto 45 mm.

JBT Essencial dispenser

White ABS 26,5 x 12 x 26 cm.
Ø max. 230 x Ø 45 mm. core roll



BAS025BK

Dispensador Higiénico Dropline

ABS acabado negro con tacto de goma, soft
27,2 x 12,5 x 25,3 cm.
Rollo Ø max. 245 x Ø canuto 45 mm.

JBT Dropline dispenser

ABS black finished with rubber touch, soft
27,2 x 12,5 x 25,3 cm.
Ø max. 245 x Ø 45 mm. core roll



BAS025WH

Dispensador Higiénico Dropline

ABS acabado blanco y cuerpo gris
27,2 x 12,5 x 25,3 cm.
Rollo Ø max. 245 x Ø canuto 45 mm.

JBT Dropline dispenser

ABS white finished and grey body
27,2 x 12,5 x 25,3 cm.
Ø max. 245 x Ø 45 mm. core roll



BAS025CHR

Dispensador Higiénico Dropline

ABS acabado metalizado
27,2 x 12,5 x 25,3 cm.
Rollo Ø max. 245 x Ø canuto 45 mm.

JBT Dropline dispenser

ABS silver painted
27,2 x 12,5 x 25,3 cm.
Ø max. 245 x Ø 45 mm. core roll

**BAS028BK****Dispensador Higiénico Dropline**

ABS acabado negro con tacto de goma, soft
32,6 x 12,5 x 30,4 cm.
Rollo Ø max. 275 x Ø canuto 45 mm.

JBT Dropline dispenser

ABS black finished with rubber touch, soft
32,6 x 12,5 x 30,4 cm.
Ø max. 275 x Ø 45 mm. core roll

NEW

**BAS028WH****Dispensador Higiénico Dropline**

ABS acabado blanco y cuerpo gris
32,6 x 12,5 x 30,4 cm.
Rollo Ø max. 275 x Ø canuto 45 mm.

JBT Dropline dispenser

ABS white finished and grey body
32,6 x 12,5 x 30,4 cm.
Ø max. 275 x Ø 45 mm. core roll

NEW

**BAS028CHR****Dispensador Higiénico Dropline**

ABS acabado metalizado
32,6 x 12,5 x 30,4 cm.
Rollo Ø max. 275 x Ø canuto 45 mm.

JBT Dropline dispenser

ABS silver painted
32,6 x 12,5 x 30,4 cm.
Ø max. 275 x Ø 45 mm. core roll

NEW

**DA0630PW****Portarrollos extracción central compacto**

ABS Blanco 20 x 13 x 20 cm.
Rollo Ø max. 150 x Ø canuto 45 mm.

Mini Interpull dispenser compact

ABS White 20 x 13 x 20 cm.
Ø max. 150 x Ø 45 mm. core roll

NEW

Ideal para su funcionamiento con la referencia EC22440P, rollo de celulosa pura de alta calidad. Pack de 18 rollos con 575 servicios por rollo de 11,5 x 20 cm.

Specially designed for operating with the reference EC22440P, pure cellulose roll high quality. Pack of 18 rolls with 575 services per roll of 11,5 x 20 cm.

Higiénico Z // V Folded Tissue dispenser**BAS005BK****Dispensador Higiénico Z Dropline**

ABS acabado negro con tacto de goma, soft
27,7 x 13,5 x 13,5 cm.
Max 500 servicios

V Folded tissue Dropline dispenser

ABS black finished with rubber touch, soft
27,7 x 13,5 x 13,5 cm.
Max 500 services

NEW

**BAS005WH****Dispensador Higiénico Z Dropline**

ABS acabado blanco y cuerpo gris
27,7 x 13,5 x 13,5 cm.
Max 500 servicios

V Folded tissue Dropline dispenser

ABS white finished and grey body
27,7 x 13,5 x 13,5 cm.
Max 500 services

NEW

**BAS005CHR****Dispensador Higiénico Dropline**

ABS acabado metalizado
27,7 x 13,5 x 13,5 cm.
Max 500 servicios

V Folded tissue Dropline dispenser

ABS silver painted
27,7 x 13,5 x 13,5 cm.
Max 500 services

NEW

Dispensadores toalla plegada // *Folded towel dispensers*



ESS300WH

Dispensador toalla Z Essencial

ABS blanco
38,3 x 13,7 x 28,5 cm.
Max 600 servicios

Z Essencial towel dispenser

White ABS
38,3 x 13,7 x 28,5 cm.
Max 600 services



BAS003BK

Dispensador toalla Z Dropline

ABS acabado negro con tacto de goma, soft
37 x 13 x 27,7 cm.
Max 600 servicios

Z Dropline towel dispenser

ABS black finished with rubber touch, soft
37 x 13 x 27,7 cm.
Max 600 services

NEW



BAS003WH

Dispensador toalla Z Dropline

ABS acabado blanco y cuerpo gris
37 x 13 x 27,7 cm.
Max 600 servicios

Z Dropline towel dispenser

ABS white finished and grey body
37 x 13 x 27,7 cm.
Max 600 services

NEW



BAS003CHR

Dispensador toalla Z Dropline

ABS acabado metalizado
37 x 13 x 27,7 cm.
Max 600 servicios

Z Dropline towel dispenser

ABS silver painted
37 x 13 x 27,7 cm.
Max 600 services

NEW

Dispensadores de jabón // *Soap dispensers*



IM-2100WH

iSoap Essencial blanco para granel

1 litro - 26 x 13,5 x 10,5 cm.

iSoap Essencial white bulk

1 litre - 26 x 13,5 x 10,5 cm.



IM-2100TBL

iSoap Azul ártico para granel

1 litro - 26 x 13,5 x 10,5 cm.

iSoap artic blue bulk

1 litre - 26 x 13,5 x 10,5 cm.



IM-2100TBK

iSoap fumé para granel

1 litro - 26 x 13,5 x 10,5 cm.

iSoap smoked bulk

1 litre - 26 x 13,5 x 10,5 cm.

**BAS001BK**

Jabonera rellenable Dropline 750
ABS acabado negro con tacto de goma, soft.
750 ml - 21 x 9 x 12,8 cm.

Dropline bulk soap dispenser 750
ABS black finished with rubber touch, soft
750 ml - 21 x 9 x 12,8 cm.

NEW

**BAS001WH**

Jabonera rellenable Dropline 750
ABS acabado blanco y cuerpo gris
750 ml - 21 x 9 x 12,8 cm.

Dropline bulk soap dispenser 750
ABS white finished and grey body
750 ml - 21 x 9 x 12,8 cm.

NEW

**BAS001CHR**

Jabonera rellenable Dropline 750
ABS acabado metalizado
750 ml - 21 x 9 x 12,8 cm.

Dropline bulk soap dispenser 750
ABS silver painted
750 ml - 21 x 9 x 12,8 cm.

NEW

**BAS002BK**

Jabonera rellenable Dropline 1000
ABS acabado negro con tacto de goma, soft.
1000 ml - 25,6 x 9 x 12,8 cm.

Dropline bulk soap dispenser 1000
ABS black finished with rubber touch, soft
1000 ml - 25,6 x 9 x 12,8 cm.

NEW

**BAS002WH**

Jabonera rellenable Dropline 1000
ABS acabado blanco y cuerpo gris
1000 ml - 25,6 x 9 x 12,8 cm.

Dropline bulk soap dispenser 1000
ABS white finished and grey body
1000 ml - 25,6 x 9 x 12,8 cm.

NEW

**BAS002CHR**

Jabonera rellenable Dropline 1000
ABS acabado metalizado
1000 ml - 25,6 x 9 x 12,8 cm.

Dropline bulk soap dispenser 1000
ABS silver painted
1000 ml - 25,6 x 9 x 12,8 cm.

NEW

Dispensador de jabón óptico rellenable // Sensor bulk soap dispenser

**IM2200SWH****Jabonera óptica rellenable**

1,1 litro - 23,5 x 10,7 x 14 cm.
Dosis 1 ml
Voltaje: 4 baterías x 1.5 V (LR6)

Sensor bulk soap

1,1 liter - 23,5 x 10,7 x 14 cm.
Dose 1 ml
Voltage: 4 batteries x 1.5 V (LR6)

NEW

Dispensadores industriales // Industrial dispensers

**IMDM702A****Dispensador industrial mural**

Sierra frontal para corte de la celulosa
40,5 x 26,5 x 37,5 cm

Industrial roll wall mounted

Front saw to cut the paper
40,5 x 26,5 x 37,5 cm













**IMDP702A****Dispensador industrial trípode**

Sierra frontal para corte de la celulosa
40,5 x 46 x 84 cm

Industrial roll stand

Front saw to cut the paper
40,5 x 46 x 84 cm

Configuraciones / Options

	<i>Dispensador mecha Center pull</i>	<i>Higiénico industrial JBT</i>	<i>Toalla plegada Folded towel</i>	<i>Jaboneras Soap dispensers</i>	<i>Higiénico Z V Folded Tissue</i>	<i>Mini mecha Mini center pull</i>
<i>Línea Esencial Essential line</i>	 ESS200WH	 ESS100BK ESS100WH	 ESS300WH ESS300BK	 IM-2100WH IM-2100TBK IM-2100TBL		
<i>Línea Drop line Drop line</i>	 BAS004WH BAS004BK BAS004CHR	 BAS025WH BAS025BK BAS025CHR BAS028WH BAS028BK BAS028CHR	 BAS003WH BAS003BK BAS003CHR	 BAS001WH BAS001BK BAS001CHR	 BAS005WH BAS005BK BAS005CHR	 BAS006WH BAS006BK BAS006CHR
Alternativas / Alternatives						
<i>Dispensador palanca Lever dispenser</i>	 TD22002		 TD22002			
<i>Autocortes Autocuts TD20102 - TD20202</i>			 TD20102 TD20103 TD20202 TD20203			
<i>Electrónicos Sensor TD24502, TD23502, TD23402</i>	 TD24502 TD24503		 TD24502 TD24503	 IM2200SWH		
<i>Portarrollos con dos rollos y mecanismo Twin and mini twin RD02702 y RD32102</i>		 RD02702 RD32102				
<i>Extracción Centerpull and interpull</i>	 TD025502	 DA0630PW				





*¿Sabías que las manos son las responsables del 80% de los contagios de las enfermedades más comunes?
La higiene de manos es la medida más eficiente en su prevención.*

*Do you know that the hands are responsible in an 80% of the common infections?
Hands hygiene is the most efficient measure from the disease prevention perspective.*

DERMEX nace fruto de la experiencia en la fabricación de productos de limpieza profesional y de sistemas de dosificación. Teniendo por objeto cuidar, limpiar y proteger la piel en un entorno laboral ó institucional. DERMEX se fabrica bajo sistemas de gestión de calidad.

Nº Reg. Cosméticos 10037DS
Nº Reg. Antisépticos 10037CS



Cargas DERMEX

con los sistemas de dosificación iSoap y Sani Suds
Los sistemas estancos de dispensación de productos para el cuidado de la piel son cómodos y ofrecen las máximas garantías de higiene, resultando idóneos para su empleo en empresas e instalaciones públicas. Las cargas DERMEX están selladas y la válvula se cambia en cada recarga, eliminando cualquier riesgo de contaminación o propagación microbiana, aspecto de suma importancia en entornos de extrema higiene como el sanitario o el alimentario.

VENTAJAS

Higiene • Control de consumo • Menos residuos • Comodidad
• Reducción de costes • Fácil recarga

CUIDADO DE LA PIEL

La adopción de buenos hábitos en el ámbito laboral es fundamental para la prevención de enfermedades cutáneas, pudiendo evitarlas mediante la aplicación habitual de productos para su limpieza y protección.
La eliminación de la suciedad y los contaminantes es de suma importancia, y tanto las manos como otras partes del cuerpo sucias, deberían limpiarse antes de los descansos o cuando vamos al servicio.
Los productos para la protección aportan hidratantes, grasas y sustancias que fijan la humedad y recuperan la piel de los esfuerzos y agresiones diversas a las que ha estado sometida durante el trabajo.

LIMPIEZA E HIGIENE

La Línea DERMEX presenta distintos productos para la limpieza suave o enérgica de las manos y para la desinfección de las mismas, con enjuague de agua o sin él, así como de uso frecuente y baño:

DERMEX M-150: Gel manos para suciedades ligeras
DERMEX B-230: Gel hidratante uso frecuente y baño
DERMEX S-370: Gel manos para alta suciedad
DERMEX D-680: Gel desinfectante de alta frecuencia
DERMEX D-730: Gel alcohol desinfectante
DERMEX H-940: Crema hidratante manos y cuerpo.
DERMEX B-410: Gel hidratante - espuma

PROTECCIÓN

La aplicación de una crema para el cuidado de la piel antes del trabajo es muy recomendable, puesto que facilita la limpieza posterior y ayuda a mantener las funciones de protección natural de la piel.
La Línea DERMEX presenta una crema indicada para la aplicación antes, durante o después del trabajo, así como para la hidratación de todo el cuerpo.

DERMEX is the result of the experience in the professional cleaning manufacturing and dispenser systems with the goal of cleaning, disinfecting and care of the skin in a professional environment. DERMEX is manufactured under quality management systems.

Nº Reg. Cosméticos 10037DS
Nº Reg. Antisépticos 10037CS



DERMEX Cartridges

For the ISoap and Sanisud dispensers.

These closed bags and pumps are easy to use and offer the maximum hygiene guarantee resulting ideal for been used in companies and public institutions.

These bags are sealed and a new pump is replaced with each one. They completely eliminates the cross contamination and microbial spreading these both aspects are critical in the medical and food industries.

ADVANTAGES

Higiene • Cost control • Waste reduction • Convenient

SKIN CARE

Good habits at the working place are fundamental for the skin diseases prevention. The regular use of these cleaning and care products could avoid these diseases.

The elimination of the dirty and contaminants is very important and the hands or other parts of the body should be cleaned before the breaks or after going to the bathroom during the workday.
The skin care products add moisture, grease and substances to fix the humidity and recover the skin from the efforts and the different aggressions that it has been suffering during the working day.

CLEANING AND HYGIENE

The DERMEX range introduces different gradual cleaners depending on how dirty are the hands and for the disinfection depending if we can rinse the hands with water or not and how frequent is the hand washing needed.

DERMEX M-150 Light and washroom cleansers
DERMEX B-230 Moisturizing cleanser for frequent use
DERMEX S-370 Heavy dirty hand cleanser
DERMEX D-680 Disinfectant cleanser for frequent use
DERMEX D-730 Alcohol disinfectant gel
DERMEX H-940 Moisturizing and repairing lotion for hands and body
DERMEX B-410 Moisturizing - foam

PROTECTION

The use of the skin care lotion before work is very recommendable because it makes easier the hand cleaning and helps to keep the natural skin protection. DERMEX introduces a skin care cream, DERMEX H940, ideal before, during and after work, applicable on hands and body because of the conditioning and moisturising of the skin.



M-150 B. 900ml

Gel de manos para suciedad normal

Para dispensador iSoap
Caja de 10 bolsas de 900 ml.
Bolsa de 900 ml.

Light and washroom cleanser

For iSoap dispenser
10 cartridges of 900 ml.
Bag of 900 ml.

B-230 B. 900ml

Gel baño hidratante y uso frecuente

Para dispensador iSoap
Caja de 10 bolsas de 900 ml.
Bolsa de 900 ml..

Moisturizing cleanser for frequent use

For iSoap dispenser
10 cartridges of 900 ml.
Bag of 900 ml

S-370 B. 900ml

Gel de manos para alta suciedad

Para dispensador iSoap
Caja de 10 bolsas de 900 ml.
Bolsa de 900 ml.

Heavy dirty hand cleanser

For iSoap dispenser
10 cartridges of 900 ml.
Bag of 900 ml



D-680 B. 900ml

Gel desinfectante de alta frecuencia

Para dispensador iSoap
Caja de 10 bolsas de 900 ml.
Bolsa de 900 ml.

Disinfectant cleanser for frequent use

For iSoap dispenser
10 cartridges of 900 ml.
Bag of 900 ml

D-730 B. 900ml

Gel alcohol desinfectante

Para dispensador iSoap
Caja de 10 bolsas de 900 ml.
Bolsa de 900 ml.

Alcohol disinfectant gel

For iSoap dispenser
10 cartridges of 900 ml.
Bag of 900 ml



H-940 B. 900ml

Crema hidratante para manos y cuerpo

Para dispensador iSoap
Caja de 10 bolsas de 900 ml.
Bolsa de 900 ml.

Moisturizing and repairing lotion for hands and body

For iSoap dispenser
10 cartridges of 900 ml.
Bag of 900 ml

Dosificadores iSoap // iSoap dispenser



IM21CARWH

Dispensador iSoap blanco
especial para cargas DERMEX
26 x 13,5 x 10,5 cm.

White iSoap dispenser
special for DERMEX cartridges
26 x 13,5 x 10,5 cm.



IM21CARTBL

Dispensador iSoap azul Ártico
especial para cargas DERMEX
26 x 13,5 x 10,5 cm.

Artic blue iSoap dispenser
special for DERMEX cartridges
26 x 13,5 x 10,5 cm.

! Promoción iSoap:
Por 2 cajas de cargas **DERMEX**
• 1 jabonera iSoap sin cargo

! iSoap special offer:
Every 2 boxes of **DERMEX**
• 1 iSoap dispenser for free



Sistema óptico o manual de dispensación de espuma de jabón

Foam soap sensor or manual dispenser system

- Elimina totalmente el riesgo de Contaminación Cruzada.

- Cargas de alta capacidad. Con más de 3.000 dosis por carga. Comparado con las 535 dosis por depósito de la jabonera a granel de 800 ml. nos da más de un 560% de dosificaciones.



- Indispensable en zonas de alto tráfico y necesidades de higiene muy elevadas, hospitales, baños infantiles y minusválidos, industria alimentaria, geriátricos, guarderías, cuarteles y zonas militares, consultas médicas, etc...

- Totally eliminates the risk of cross contamination

- High capacity cartridges.with more than 3000 doses per bag. If you compare this system with a bulk soap dispenser, it provides 560% more doses, 3000 against 535.



- These are indispensable in high traffic areas and high hygiene standards like hospitals, children's bathrooms and people with disabilities, food industry, military headquarters, geriatric centers, kindergarden ... etc.



SF030502
Dispensador espuma Sani Suds negro
 Óptico. Especial para cargas DERMEX B-410
 28,8 x 12,5 x 12,5 cm.
Sani Suds black soap dispenser
 Sensor special for DERMEX B-410
 28,8 x 12,5 x 12,5 cm.



SF040702
Dispensador espuma Sani Suds negro
 con pulsador. Especial para cargas DERMEX B-410
 28,8 x 12,5 x 12,5 cm.
 Sani Suds black soap dispenser
 Manual, special for DERMEX B-410
 28,8 x 12,5 x 12,5 cm.

**SF030503**

Dispensador espuma Sani Suds blanco
Óptico. Especial para cargas DERMEX B-410
28,8 x 12,5 x 12,5 cm.

Sani Suds white soap dispenser
Sensor special for DERMEX B-410
28,8 x 12,5 x 12,5 cm.

**SF040703**

Dispensador espuma Sani Suds blanco
Con pulsador. Especial para cargas
DERMEX B-410
28,8 x 12,5 x 12,5 cm.

Sani Suds white soap dispenser
Manual, special for DERMEX B-410
28,8 x 12,5 x 12,5 cm.

**B-410 B. 1200ml**

Carga gel de manos hidratante Espuma
Para dispensador Sani Suds
Caja de 5 bolsas de 1.200 ml.
Más de 3.000 dosis por bolsa
Bolsa de 1.200 ml.

Moisturizing foam hand cleanser cartridge
For Sani Suds dispenser
5 bag box of 1.200 ml
More than 3.000 doses per bag
Bag of 1.200 ml.

ISO 9001
BUREAU VERITAS
Certification



ISO 14001
BUREAU VERITAS
Certification

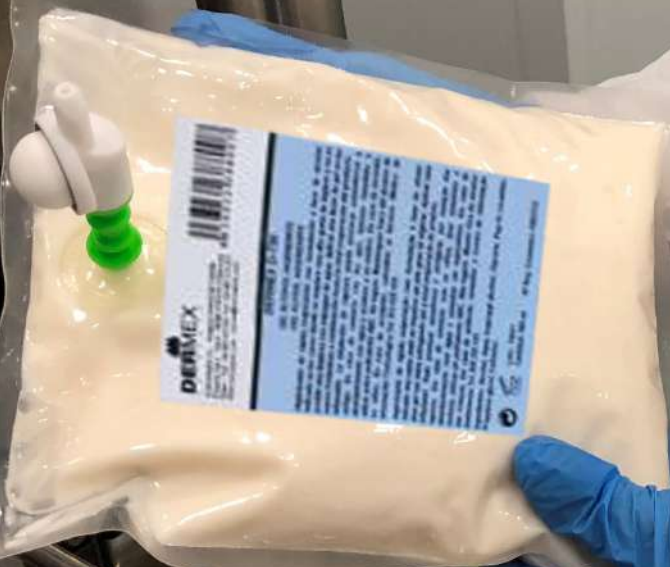

Vestuario laboral

Professional clothing

***Ambientes
recomendados
para el uso de
las prendas***
***Recommended
enviroments***

-  Alimentación
Food industry / service
-  Limpieza
Janitorial
-  Servicios
Services
-  Sanidad
Health care
-  Hostelería
Hospitality
-  Industria
Industry



Carta de colores y telas

Color and fabric options

Color base // Color base

05 Amarillo Yellow	10 Azul claro Light blue	15 Azul medio Medium blue	20 Azul oscuro Dark blue	25 Blanco White	30 Burdeos Burgundy	35 Gris claro Light grey	40 Gris oscuro Dark grey	45 Marrón claro Light brown	50 Marrón oscuro Dark brown	55 Morado Purple	60 Pistacho Pistachio
65 Naranja Orange	70 Negro Black	75 Rojo Red	80 Verde claro Light green	85 Verde oscuro Dark green	90 Rosa Pink	95 Verde oliva Olive green	100 Fucsia Fuchsia				

Color bias (contraste) // Bias binding tape color (contrasting)

05 Amarillo Yellow	10 Azul claro Light blue	15 Azul medio Medium blue	20 Azul oscuro Dark blue	25 Blanco White	30 Burdeos Burgundy	60 Pistacho Pistachio	65 Naranja Orange	70 Negro Black	75 Rojo Red	85 Verde oscuro Dark green
---------------------------------	---------------------------------------	--	---------------------------------------	------------------------------	----------------------------------	------------------------------------	--------------------------------	-----------------------------	--------------------------	---

Color cinta y puños elásticos

Tape and elastic wrist color



05 Amarillo Yellow	10 Azul claro Light blue	20 Azul oscuro Dark blue	25 Blanco White	35 Gris claro Light grey	50 Marrón oscuro Dark brown	65 Naranja Orange	70 Negro Black	75 Rojo Red	85 Verde oscuro Dark green
---------------------------------	---------------------------------------	---------------------------------------	------------------------------	---------------------------------------	--	--------------------------------	-----------------------------	--------------------------	---

Color cremallera

Zipper color

25 Blanco White	30 Burdeos Burgundy	70 Negro Black
------------------------------	----------------------------------	-----------------------------

Telas // Fabrics

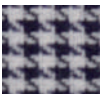
	CP Cuadros Pequeños Small square
	RA Rayas Azules Blue striped
	RN Rayas Negras Black striped
	PG Pata de Gallo Houndstooth

Rejillas // Perforated fabric

	R95B Rejilla 95 Blanca 95 calados por cm ² White perforated fabric 95 95 holes per cm ²
	R25G Rejilla 25 Gris 25 calados por cm ² Grey perforated fabric 25 25 holes per cm ²
	R25A Rejilla 25 Azul 25 calados por cm ² Blue perforated fabric 25 25 holes per cm ²
	R25B Rejilla 25 Blanco 25 calados por cm ² White perforated fabric 25 25 holes per cm ²
	R25N Rejilla 25 Negra 25 calados por cm ² Black perforated fabric 25 25 holes per cm ²

Tallaje // Measurement

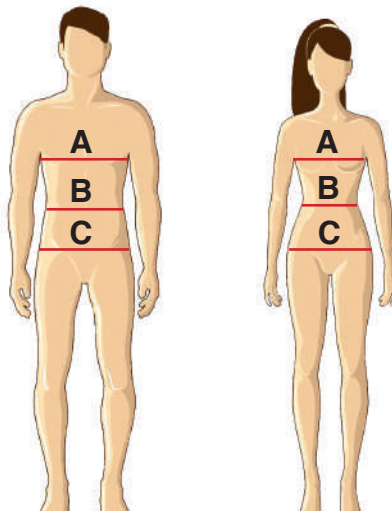
A contorno de pecho (cm)	
A chest contour (cm)	
B contorno de cintura (cm)	
B waist contour (cm)	
C contorno de caderas (cm)	
C hips contour (cm)	

Casullas Poliéster // Polyester cobbler apron



SISTEMA DE CODIFICACIÓN CODE SYSTEM

REF XXX XX XX
TALLA COLOR BIES
SIZE COLOR BIAS



IM146 001 70
IM146 002 70
IM146 003 70

Casulla Poliéster
Polyester cobbler apron

Tallas/size:
001 50 x 78 cm.
002 50 x 87 cm.
003 70 x 90 cm.

Color base: **70**
Color base
Color bias (contraste) / Bias binding tape (contrasting):
25 60 65 70 75 85



IM146 001 25
IM146 002 25
IM146 003 25

Casulla Poliéster
Polyester cobbler apron

Tallas/size:
001 50 x 78 cm.
002 50 x 87 cm.
003 70 x 90 cm.

Color base: **25**
Color base
Color bias (contraste) / Bias binding tape (contrasting):
25 60 65 70 75 85



IM146 001 30
IM146 002 30
IM146 003 30

Casulla Poliéster
Polyester cobbler apron

Tallas/size:
001 50 x 78 cm.
002 50 x 87 cm.
003 70 x 90 cm.

Color base / Color base **30**
Color bias (contraste) / Bias binding tape (contrasting):
25 30 70



IM146 001 65
IM146 002 65
IM146 003 65

Casulla Poliéster
Polyester cobbler apron

Tallas/size:
001 50 x 78 cm.
002 50 x 87 cm.
003 70 x 90 cm.

Color base / Color base **65**
Color bias (contraste) / Bias binding tape (contrasting):
25 65 70

Personalización Casulla Poliéster / Polyester cobbler apron customization

Color base / Color base
70 25 30 65

Color bias (contraste) / Bias binding tape (contrasting):
05 10 15 20 25 30 65 70 75 85

Tallas: Mínimo 6 unidades por talla.
Sizes: Minimum 6 units per size.

Casullas Sarga // Polycotton cobbler apron

(65% Poliéster 35% algodón)

(65% polyester 35% cotton)



IM126 001 25
IM126 002 25
IM126 003 25

Casulla sarga
Polycotton cobbler apron

Tallas/size:
001 50 x 78 cm.
002 50 x 87 cm.
003 70 x 90 cm.

Color base / Color base

25

Color bias (contraste)

Bias binding tape (contrasting):

25 65 75 85



IM126 001 30
IM126 002 30
IM126 003 30

Casulla sarga
Polycotton cobbler apron

Tallas/size:
001 50 x 78 cm.
002 50 x 87 cm.
003 70 x 90 cm.

Color base / Color base

30

Color bias (contraste)

Bias binding tape (contrasting):

25 30 70



IM126 001 20
IM126 002 20
IM126 003 20

Casulla sarga
Polycotton cobbler apron

Tallas/size:
001 50 x 78 cm.
002 50 x 87 cm.
003 70 x 90 cm.

Color base / Color base

20

Color bias (contraste)

Bias binding tape (contrasting):

25 20 70

Personalización Casulla Sarga y volantes / Polycotton cobbler apron customization

Tallas: Mínimo 6 unidades por talla. Sizes: Minimum 6 units per size.

Color base / Color base



Color bias (contraste) / Color bias (contraste):





SISTEMA DE CODIFICACIÓN

CODE SYSTEM

REF XX

COLOR
COLOR



IM117BX

Delantal corto 3 bolsillos
3 pocket waist apron

Talla única 60 x 28 cm.
One size fits all
Color base / Color base



IM116BX

Delantal corto 2 bolsillos
2 pocket waist apron

Talla única 70 x 42 cm.
One size fits all
Color base / Color base



IM100X

Delantal francés sin bolsillo
No pocket French chef apron

Talla única 95 x 95 cm.
One size fits all
Color base / Color base



IM100BX

Delantal francés con 2 bolsillos
2 pocket French chef apron

Talla única 95 x 95 cm.
One size fits all
Color base / Color base



IM101X

Delantal argentino con apertura sin bolsillo
No pocket gaucho chef apron

Talla única 85 x 90 cm.
One size fits all

Color base / Color base



IM101BX

Delantal argentino con 2 bolsillos y apertura
2 pocket gaucho chef apron with opening

Talla única 85 x 90 cm.
One size fits all

Color base / Color base





IM165BX

Delantal sumiller con 2 bolsillos
2 pocket sumiller apron

Talla única 75 x 125 cm.
 One size fits all

Color base / Color base

30

70



IM114BX

Delantal peto con 2 bolsillos
2 pocket pib apron

Talla única 70 x 87 cm.
 One size fits all

Color base / Color base

25

30

70



Delantales Sarga
(65% Poliéster 35% algodón)

// **Polycotton aprons**
(65% Polyester 35% cotton)



SISTEMA DE CODIFICACIÓN
CODE SYSTEM
REF XX
COLOR
COLOR



IM117SB 25
IM117SB xx

Delantal corto sin bolsillos
No pocket waist apron

Talla única 60 x 42 cm.
One size fits all

Color base / Color base

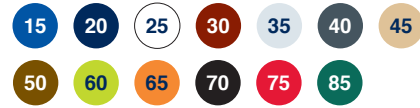

IM117B 25
IM117B xx

Delantal corto 3 bolsillos
3 pocket waist apron

Talla única 60 x 28 cm.
One size fits all

Color base / Color base

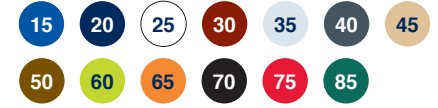

IM116B 25
IM116B xx

Delantal corto 2 bolsillos
2 pocket waist apron

Talla única 70 x 42 cm.
One size fits all

Color base / Color base



IM100 25
IM100 xx

Delantal francés sin bolsillo
No pocket French chef apron

Talla única 95 x 95 cm.
One size fits all

Color base / Color base

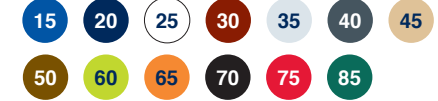

IM100B 25
IM100B xx

Delantal francés con 2 bolsillos
2 pocket French chef apron

Talla única 95 x 95 cm.
One size fits all

Color base / Color base





IM101 25
IM101 xx

Delantal argentino con apertura sin bolsillo
No pocket gaucho chef apron with opening

Talla única 85 x 90 cm.
One size fits all

Color base / Color base



IM101B 25
IM101B xx

Delantal argentino con 2 bolsillos y apertura
2 pocket gaucho chef apron with opening

Talla única 85 x 90 cm.
One size fits all

Color base / Color base

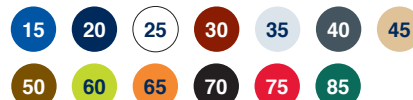

IM114B 25
IM114B xx

Delantal peto con 2 bolsillos
2 pocket pib apron

Talla única 70 x 87 cm.
One size fits all

Color base / Color base

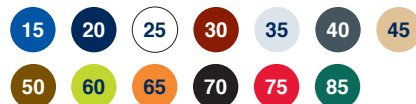

IM165 xx

Delantal sumiller con 2 bolsillos
2 pocket sumilier apron

Talla única 75 x 125 cm.
One size fits all

Color base / Color base

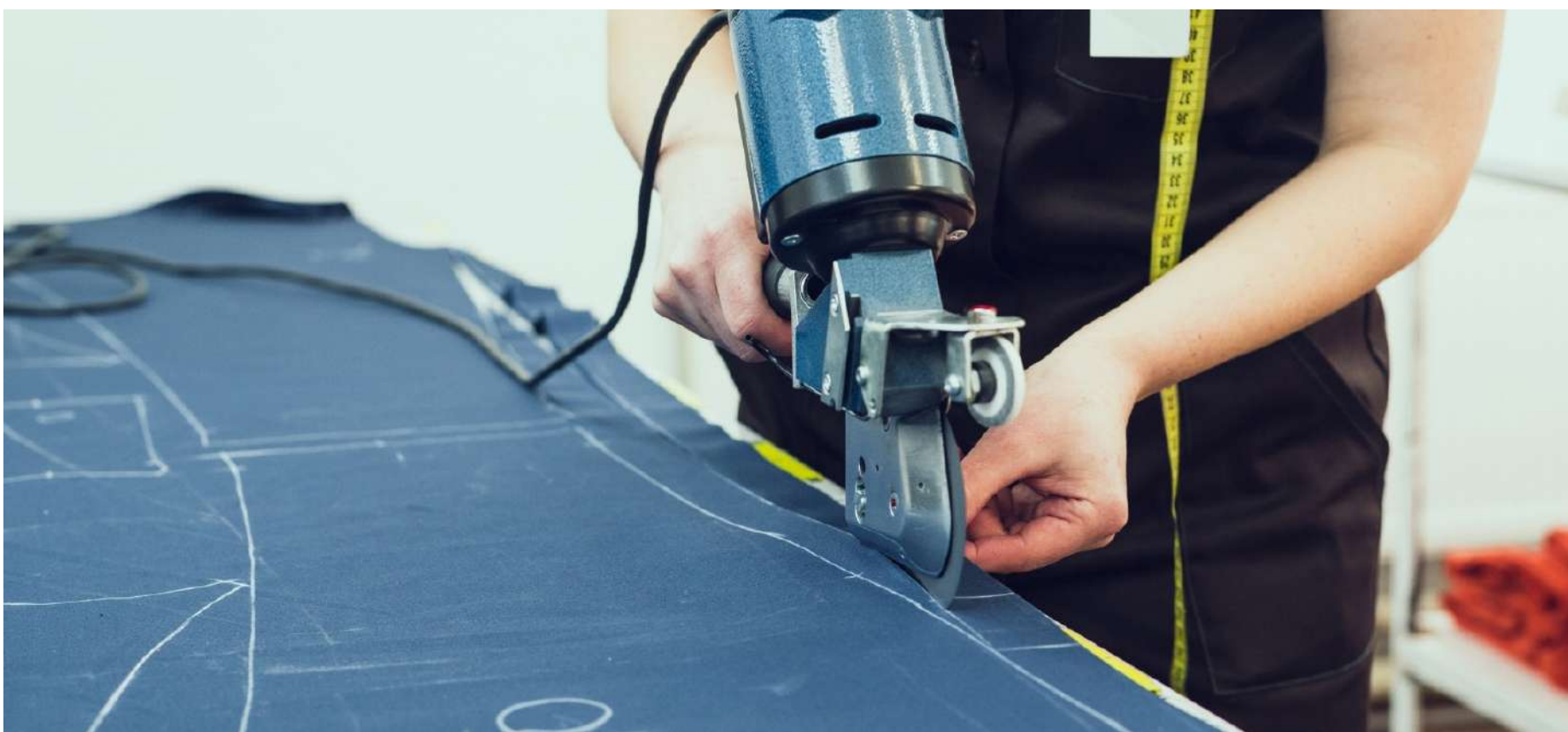

Delantales resistentes al agua // Waterproof apron



614DVA-BL

Delantal resistente al agua

91,44 x 109,22 cm.
Vinilo Azul 200 micras.

Waterproof apron

Blue vinyl 200 microns.

614DVA-WH

Delantal resistente al agua

91,44 x 109,22 cm.
Vinilo Blanco 150 micras

Waterproof apron

White vinyl 150 microns

614DVA-WH8

Delantal resistente al agua

91,44 x 109,22 cm.
Vinilo Blanco 200 micras

Waterproof apron

White vinyl 200 microns

614DVA-WH20

Delantal resistente al agua

91,44 x 114,30 cm.
Vinilo Blanco 500 micras

Waterproof apron

White vinyl 500 microns

614DVA-GN20

Delantal resistente al agua

91,44 x 114,30 cm.
Vinilo Verde 500 micras

Waterproof apron

Green vinyl 500 microns

Guantes // Gloves



801SG13

Guante de silicona congelación y calor

330 mm. largo -18°C hasta 200°C 1 par

Silicone glove frozen and hot food

330 mm. length -18°C up to 200°C
1 pair

801SG15

Guante de silicona congelación y calor

381 mm. largo -18°C hasta 200°C 1 par

Silicone glove frozen and hot food

381 mm. length -18°C up to 200°C
1 pair

801SG17

Guante de silicona congelación y calor

432 mm. largo -18°C hasta 200°C 1 par

Silicone glove frozen and hot food

432 mm. length -18°C up to 200°C
1 pair



T1212

Guante de Neopreno para Rustir

305 mm. largo hasta 260°C 1 par

Neoprene rotissi glove

305 mm. length up to 260°C
1 pair

T1217

Guante de Neopreno para Rustir

432 mm. largo hasta 260°C 1 par

Neoprene rotissi glove

432 mm. length up to 260°C
1 pair

**800FG13**

Manopla con kevlar BestGuard
330 mm. largo hasta 230°C 1 par
Kevlar BestGuard mitt
330 mm. length up to 230°C 1 pair

801SG15

Manopla con kevlar BestGuard
381 mm. largo hasta 230°C 1 par
Kevlar BestGuard mitt
381mm. length up to 230°C 1 pair

801SG17

Manopla con kevlar BestGuard
432 mm. largo hasta 230°C 1 par
Kevlar BestGuard mitt
432 mm. length up to 230°C 1 pair

**813TMSB**

Manopla protección vapor y calor
330 mm. largo hasta 260°C 1 par
Steam and heat protection mitt
330 mm. length up to 260°C 1 pair

817TMSB

Manopla protección vapor y calor
432 mm. largo hasta 260°C 1 par
Steam and heat protection mitt
432 mm. length up to 260°C 1 pair

**SG10-WH**

Guante anticorte
Blanco
Nivel de protección 5 1 unidad
Anticut glove
White
Protection level 5 1 unit

**SG10-BL**

Guante anticorte
Azul (mariscos)
Nivel de protección 5 1 unidad

SG10-GN

Guante anticorte
Verde (frutas y vegetales)
Nivel de protección 5 1 unidad



Anticut glove
Blue (seafood)
Protection level 5 1 unit

Anticut glove
Green (fruits and vegetables)
Protection level 5 1 unit

**SG10-RD**

Guante anticorte
Rojo (carnes)
Nivel de protección 5 1 unidad

SG10-YL

Guante anticorte
Amarillo (aves)
Nivel de protección 5 1 unidad



Anticut glove
Red (meat)
Protection level 5 1 unit

Anticut glove
Yellow (poultry)
Protection level 5 1 unit



SISTEMA DE CODIFICACIÓN

CODE SYSTEM

REF XXX XX

TALLA COLOR

SIZE COLOR



IM600 25
IM600 XX

Bata manga corta unisex
Unisex short sleeves lab coat

Talla S M L XL XXL
106 112 118 124 130
Medidas pecho en cm.
Largo 108 cm.
Chest contour (cm.)
Length 108 cm.

Color base / Color base



IM630 25
IM630 XX

Bata manga corta mujer
Woman short sleeves lab coat

Talla S M L XL XXL
103 109 115 121 127
Medidas pecho en cm.
Largo 108 cm.
Chest contour (cm.)
Length 108 cm.

Color base / Color base



IM400 25

Chaqueta pico unisex
V collar unisex jacket

Talla S M L XL XXL
110 118 125 134 142
Medidas pecho en cm.
Largo 108 cm.
Chest contour (cm.)
Length 108 cm.

Color base / Color base



IM500 25
IM500 xx

Bata larga sin mangas
No sleeves long lab coat

Talla S M L XL XXL
89 95 101 107 113
Medidas pecho en cm.
Largo 108 cm.
Chest contour (cm.)
Length 108 cm.

Color base / Color base



IM610 25
IM610 XX

Bata manga larga unisex
Unisex long sleeves lab coat

Talla S M L XL XXL
106 112 118 124 130
Medidas pecho en cm.
Largo 108 cm.
Chest contour (cm.)
Length 108 cm.

Color base / Color base



IM640 25
IM640 XX

Bata manga larga mujer
Woman long sleeves lab coat

Talla S M L XL XXL
103 109 115 121 127
Medidas pecho en cm.
Largo 108 cm.
Chest contour (cm.)
Length 108 cm..

Color base / Color base



**IM600P 25**

Bata manga corta unisex Popelín
Poplin unisex short sleeves lab coat

Talla S M L XL XXL
106 112 118 124 130
Medidas pecho en cm.
Largo 108 cm.
Chest contour (cm.)
Length 108 cm.

Color base / Color base

25

**IM630P 25**

Bata manga corta mujer Popelín
Poplin woman short sleeves lab coat

Talla S M L XL XXL
103 109 115 121 127
Medidas pecho en cm.
Largo 108 cm.
Chest contour (cm.)
Length 108 cm

Color base / Color base

25

**IM610P 25**

Bata manga larga unisex Popelín
Poplin unisex long sleeves lab coat

Talla S M L XL XXL
106 112 118 124 130
Medidas pecho en cm.
Largo 108 cm.
Chest contour (cm.)
Length 108 cm..

Color base / Color base

25

**IM640P 25**

Bata manga larga mujer Popelín
Poplin woman long sleeves lab coat

Talla S M L XL XXL
103 109 115 121 127
Medidas pecho en cm.
Largo 108 cm.
Chest contour (cm.)
Length 108 cm.

Color base / Color base

25





SISTEMA DE CODIFICACIÓN
CODE SYSTEM

REF XXX XX
TALLA COLOR
SIZE COLOR



NEW

IM211 25

Camisola pijama sarga alimentaria
Food industry polycotton long sleeve shirt

Talla	XS	S	M	L	XL	XXL
Pecho	96	102	108	114	120	128
Chest						
Largo	73	73	73	75	78	80
Length						
(cm.)						

Color base / Color base

25

Detalle puño
Elastic wrist detail



NEW

IM311 25

Pantalón pijama sarga alimentaria
Food industry polycotton pant

Talla	XS	S	M	L	XL	XXL
Cintura	86	90	94	98	102	106
Waist						
Largo	108	108	108	108	108	108
Length						
(cm.)						

Color base / Color base

25

Detalle bolsillo
Pocket detail



NEW

IM611C 25

Bata cremallera manga larga unisex
popelín alimentaria
Food industry zipper popelin unisex long
sleeves lab coat

Talla	S	M	L	XL	XXL
	106	112	118	124	130
Medidas pecho en cm.					
Largo 108 cm.					
Chest contour (cm.)					
Length 108 cm..					

Color base / Color base

25

Detalle cremallera
y puño
Zipper detail
Elastic wrist detail



NEW

IM611V 25

Bata velcro manga larga unisex popelín
alimentaria
Food industry velcro popelin unisex long
sleeves lab coat

Talla	S	M	L	XL	XXL
	106	112	118	124	130
Medidas pecho en cm.					
Largo 108 cm.					
Chest contour (cm.)					
Length 108 cm..					

Color base / Color base

25

Detalle puño
Elastic wrist detail



NEW

IM511 xxx 20

Gorro tela mantenimiento con faldón de rejilla auto ajustable.
Talla única.

Autoajustable hair net peaked cap
One size

Color visera
Band color

20

Modelo de rejilla
Net



R25A

Batas sarga y popelín // Polycotton and poplin lab coat

(Personalización) (Customization)



Personalización Batas sarga y popelín / Polycotton and poplin lab coat customization

SISTEMA DE CODIFICACIÓN REF XXX XX XX
CODE SYSTEM TALLA COLOR CONTRASTE
SIZE COLOR BIAS

Batas Sarga IM600 , IM610, IM630, IM640 y IM400
Polycotton lab coat IM600 , IM610, IM630, IM640
y IM400

Mínimo 6 unidades por talla.
/ Minimum 6 units per size



IM500

Batas Sarga
Polycotton lab coat

Mínimo 6 unidades por talla.
Minimum 6 units per size.

Otras variantes posibles para la personalización de las Batas son:

- Bolsillos:
(a) 1, 2, ó 3 bolsillos interiores (cuadrados o redondos)
- Variantes para abrochar:
(a) Botones
(b) Botones y Cubrebotones
(c) Corchete
(d) Corchete+Cubrecorchete
(e) Velcro
- Variantes de puño:
(a) Puño elástico de colores

Color base y contrastes en cuellos, bolsillos, mangas y puños elásticos
Base color and bias in collar, pockets, sleeves and elastic wrist:

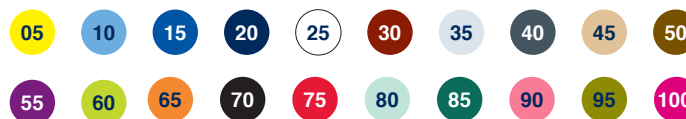

Color bias / Color bias

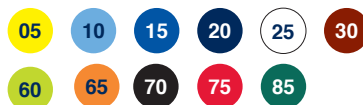

Color cinta y puños elásticos / Tape and elastic wrist color



Batas Popelín IM600P , IM610P, IM630P
Poplin lab coat IM600P , IM610P, IM630P

Mínimo 6 unidades por talla.
/ Minimum 6 units per size.



Other possibilities for lab coat customization are:

- Pocket:
(a) 1, 2, ó 3 interior pockets (squared or rounded)
- Fasteners types:
(a) Button
(b) Button and button-cover
(c) Snap button
(d) Snap button+button-cover
(e) Velcro
- Wrist types:
(a) Elastic wrist color



Chaleco Poliéster

// Polyester vest jacket



IM1002

Chaleco señora poliéster
Woman polyester vest jacket

Talla S M L XL XXL
94 98 102 106 110
Medidas pecho en cm.
Largo 73 cm.
Chest contour (cm.)
Length 73 cm.

Color base, Color bias y cremallera
Color base, Color bias y zipper



Chaleco Sarga (65% poliéster 35% algodón)

// Polycotton vest jacket
(65% polyester 35% cotton)



IM1001 25

IM1001 xx

Chaleco señora sarga
Woman polycotton vest jacket

Talla S M L XL XXL
94 98 102 106 110
Medidas pecho en cm.
Largo 73 cm.
Chest contour (cm.)
Length 73 cm.

Color base, Color bias y cremallera
Color base, Color bias y zipper



Personalización Chaleco sarga / Polycotton vest jacket customization

Tallas: Mínimo 6 unidades por talla. Size: Minimum 6 units per size

SISTEMA DE CODIFICACIÓN CODE SYSTEM

REF XXX XX XX XX
TALLA COLOR BIAS CREM
SIZE COLOR BIAS ZIPPER

Color base / Color base



Color bias (contraste) / Bias color (contrasting)

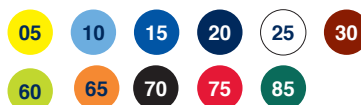

Color cremallera / Zipper color



Pijama Sarga

(65% poliéster 35% algodón)

// *Polycotton scrub, shirt and pants*
(65% polyester 35% cotton)



IM200 25

Camisola pijama sarga
Polycotton shirt

Talla	XS	S	M	L	XL	XXL
Pecho Chest	96	102	108	114	120	128
Largo Length (cm.)	73	73	73	75	78	80

IM200 xx

Color base
Color base



IM300 25

Pantalón pijama sarga
Polycotton pant

Talla	XS	S	M	L	XL	XXL
Cintura Waist	86	90	94	98	102	106
Largo Length (cm.)	108	108	108	108	108	108

IM300 xx

Color base
Color base



Camisola pijama Popelín // Poplin scrub shirt



IM200P 25

Camisola pijama Popelín
Poplin scrub shirt

Talla	XS	S	M	L	XL	XXL
Pecho Chest	96	102	108	114	120	128
Largo Length (cm.)	73	73	73	75	78	80

Color base
Color base

25



Camisola pijama Sarga

(65% poliéster 35% algodón)

// *Polycotton shirt*
(65% polyester 35% cotton)



SISTEMA DE CODIFICACIÓN CODE SYSTEM

REF XXX XX XX
TALLA COLOR BIES
SIZE COLOR BIAS



IM220 25
IM220 XX XX

Camisola pijama sarga
Polycotton shirt

Talla	XS	S	M	L	XL	XXL
Pecho	96	102	108	114	120	128
Chest						
Largo	70	70	70	71	73	75
Length (cm)						

Color base, Color bias
Base, bias color



Personalización Customization

IM200, IM300, IM220 y IM201
IM200, IM300, IM220 y IM201

Tallas: Mínimo 6 unidades por talla. Size: Minimum 6 units per size

Color base / Color base



Color bias (contraste) / Color bias

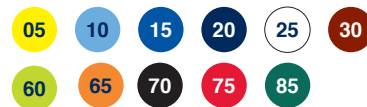

IM200P
IM200P

Tallas: Mínimo 6 unidades por talla. Size: Minimum 6 units per size

Color base / Color base



SISTEMA DE CODIFICACIÓN CODE SYSTEM

REF XXX XX
TALLA COLOR
SIZE COLOR

Chaqueta Chef // Chef Jacket

SISTEMA DE CODIFICACIÓN CODE SYSTEM

REF XXX XX
TALLA COLOR
SIZE COLOR



IMJ01 XXX 25
IMJ01 XXX XX

Chaqueta chef clásica unisex manga larga con cubre corchetes y doble bolsillo termómetro
Classic unisex long sleeve with snap-button-cover and double thermometer pocket, chef jacket

Talla	XS	S	M	L	XL	XXL
Pecho	110	116	122	128	136	144
Chest						
Largo	70	70	72	76	76	80
Length (cm.)						

Color base
Color base

25 50 70



IMJ03 XXX 25
IMJ03 XXX XX

Chaqueta chef clásica unisex manga larga con botones y doble bolsillo termómetro
Classic unisex long sleeve with buttons and double thermometer pocket, chef jacket

Talla	XS	S	M	L	XL	XXL
Pecho	110	116	122	128	136	144
Chest						
Largo	70	70	72	76	76	80
Length (cm.)						

Color base
Color base

25 50 70





IMJ04 XXX 25
IMJ04 XXX XX

Chaqueta chef clásica unisex manga corta con botones y doble bolsillo termómetro
 Classic unisex short sleeve with buttons and double thermometer pocket, chef jacket

Talla	XS	S	M	L	XL	XXL
Pecho	110	116	122	128	136	144
Chest						
Largo	70	70	72	76	76	80
Length (cm.)						

Color base
 Color base



IMJ05 XXX 25
IMJ05 XXX XX

Chaqueta chef combinada unisex con botones y doble bolsillo termómetro
 Unisex colored with buttons and double thermometer pocket, chef jacket

Talla	XS	S	M	L	XL	XXL
Pecho	110	116	122	128	136	144
Chest						
Largo	70	70	72	76	76	80
Length (cm.)						

Color base
 Color base



Personalización
 Customization

IMJ01, IMJ03, IMJ04 y IMJ05 (con puños y cuello negro)
 IMJ01, IMJ03, IMJ04 y IMJ05 (black wrist and neck)

Tallas: Mínimo 6 Size: Minimum 6
 unidades por talla. units per size

Color base / Color base



Pantalón Chef // Chef Pant



Detalle bolsillo
camal RA y RN
Pocket detail
leg RA y RN



IM300 XXX 25
IM300 XXX XX / CP
IM300 XXX RA / RN / PG

Pantalón chef unisex todo goma
Unisex elastic band chef pants

Talla	XS	S	M	L	XL	XXL
Cintura	86	90	94	98	102	106
Waist						
Largo	106	106	106	106	106	106
Length (cm.)						

Color base
Color base



CP

RA

RN

PG



Gorros // Chef Hat

SISTEMA DE CODIFICACIÓN CODE SYSTEM

REF XX
COLOR
COLOR



IM672 25
IM672 XX / CP
IM672 RA / RN / PG

Gorro Chef tradicional
Talla única
Traditional chef hat
One size fits all

Color base
Color base

25 30 70

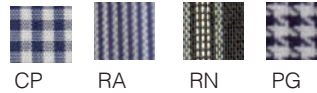

IM670 25
IM670 XX / CP
IM670 RA / RN / PG

Gorro modelo asiático
Talla única
Asiatic model chef hat
One size fits all

Color base
Color base

25 30 70

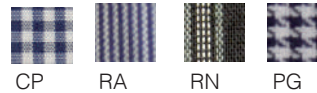

IM673 25
IM673 XX / CP
IM673 RA / RN / PG

Bandana
Talla única
Bandana
One size fits all

Color base
Color base

25 30 70

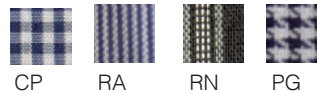

Personalización Customization

IM672, IM670 y IM673
IM672, IM670 y IM673

Tallas: Mínimo 12 unidades.
Size: Minimum 12 units per size

Color base / Color base



Cofias // Food industry hat and hair nets



SISTEMA DE CODIFICACIÓN CODE SYSTEM

REF XX
COLOR COLOR
xxx REJILLA
NET



IM650

Cofia con visera y rejilla recogepelos
Talla única.

Hair net peaked
One size



Color visera
Peak color



Modelo de rejilla
Net

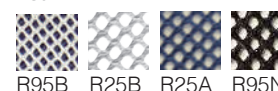

IM650B

Cofia con cinta elástica y rejilla recogepelos
Tamaño cinta: 7 cm. de ancho.
Talla única.

Hair net with elastic band
Elastic band size: 7 cm. width.
One size



Color cinta
Band color



Modelo de rejilla
Net

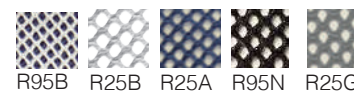

Personalización Customization

IM650 y IM650B IM650 y IM650B

Tallas: Mínimo 12 unidades.

Size: Minimum 12 units per size

Color visera / Peak color



Color cinta elástica / Elastic band color



Modelo de rejilla / Net

	R95B	
	Rejilla 95 Blanca	White perforated fabric 95
	95 calados por cm ²	95 holes per cm ²
	Rejilla 25 Gris	Grey perforated fabric 25
	25 calados por cm ²	25 holes per cm ²
	Rejilla 25 Azul	Blue perforated fabric 25
	25 calados por cm ²	25 holes per cm ²
	Rejilla 25 Blanco	White perforated fabric 25
	25 calados por cm ²	25 holes per cm ²
	Rejilla 25 Negra	Black perforated fabric 25
	25 calados por cm ²	25 holes per cm ²



SISTEMA DE CODIFICACIÓN
CODE SYSTEM

REF XX
COLOR
COLOR



IM652 xxx 25
IM652 xxx xx

Gorro tela con tapa de rejilla
Talla S/M Ø 58 cm - Talla L/XL Ø 64 cm
Hair net top peaked cap
Size S/M Ø 58 cm - Size L/XL Ø 64 cm

Color visera
Peak color

Modelo de rejilla
Net

25 30 70

R95B



IM654 25
IM654 xx

Gorro tela con tapa y recogepelos de rejilla
Talla única
Hair net and net on top peaked cap
One size

Color cinta
Band color

Modelo de rejilla
Net

25 20

R95B



IM660M xxx 25
IM660M xxx xx

Gorro tela con recogepelos de rejilla
Talla S/M Ø 58 cm - Talla L/XL Ø 64 cm
Hair net peaked cap
Size S/M Ø 58 cm - Size L/XL Ø 64 cm

Color visera
Band color

Modelo de rejilla
Net

25 20

R95B



IM655 25
IM655 xx

Gorro aviador tela con tapa de rejilla
Talla única
Aviator polycotton with net on top cap
One size

Color cinta
Band color

Modelo de rejilla
Net

25 30 70

R95B

Personalización
Customization

IM652, IM654,
IM660M y IM655

Tallas: Mínimo 12 unidades.

Size: Minimum 12 units per size

Color base / Color base



Modelo de rejilla / Modelo de rejilla



R95B
Rejilla 95 Blanca
95 calados por cm²
White perforated fabric 95
95 holes per cm²



R25G
Rejilla 25 Gris
25 calados por cm²
Grey perforated fabric 25
25 holes per cm²



R25A
Rejilla 25 Azul
25 calados por cm²
Blue perforated fabric 25
25 holes per cm²

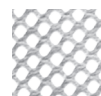

R25B
Rejilla 25 Blanco
25 calados por cm²
White perforated fabric 25
25 holes per cm²



R25N
Rejilla 25 Negra
25 calados por cm²
Black perforated fabric 25
25 holes per cm²

Capuces // Food industry hoods



IM690

Capuz de popelín con tapa de rejilla
Talla única.

Poplin hood with net on top
One size

Color
Color

25

Modelo de rejilla
Net



R95B



IM691

Capuz punto y popelín
Talla única.

Poplin and knit hood
One size

Color
Color

25



M693

Capuz de rejilla con cinta elástica y recogepelos
Talla única.

Net with elastic band and hair net hood
One size

Color
Color

25

Modelo de rejilla
Net



R95B

Personalización Customization

Tallas: Mínimo 96
unidades.

Sizes: Minimum
96 units per size.

IM693, IM690, IM691

Color cinta elástica / Elastic band color



Popelin / Poplin



Modelo de rejilla / Net



R95B

Rejilla 95 Blanca White perforated fabric 95
95 calados por cm² 95 holes per cm²



R25G

Rejilla 25 Gris Grey perforated fabric 25
25 calados por cm² 25 holes per cm²



R25A

Rejilla 25 Azul Blue perforated fabric 25
25 calados por cm² 25 holes per cm²

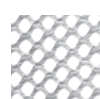

R25B

Rejilla 25 Blanco White perforated fabric 25
25 calados por cm² 25 holes per cm²



R25N

Rejilla 25 Negra Black perforated fabric 25
25 calados por cm² 25 holes per cm²

Manguitos // Sleeve cover



IM020 25
IM020 XX

Manguito pack de dos
Talla única. 16 x 35 cm.

Sleeve cover 2 per pack
One size 16 x 35 cm.

Color base
color base



Personalización Customization

Tallas: Mínimo 12
unidades.

Size: Minimum 12
units per size

Color base / Color base

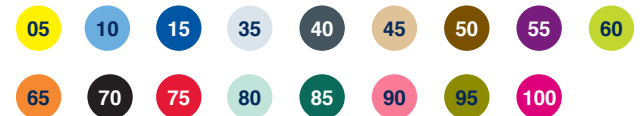

Polo piqué y pantalón multibolsillos // Pique polo shirt and cargo pant



SISTEMA DE CODIFICACIÓN CODE SYSTEM

REF **XXX XX**
TALLA COLOR
SIZE COLOR



IM250
Polo piqué manga larga
Long sleeve pique polo shirt

Talla	XS	S	M	L	XL	XXL
Pecho	86	104	112	120	128	136
Chest	68	68	70	72	74	76
Largo	68	68	70	72	74	76
Length (cm.)						

Color base / Color base



IM251
Polo piqué manga corta
Short sleeve pique polo shirt

Talla	XS	S	M	L	XL	XXL
Pecho	86	104	112	120	128	136
Chest	68	68	70	72	74	76
Largo	68	68	70	72	74	76
Length (cm.)						

Color base / Color base



Personalización Customization

IM250, IM251

Mínimo 36
unidades en total
y 6 por talla.

Size:
Minimum 36 units
6 per size

IM350

Mínimo 6 por talla. Minimum 6 per size

Color base / Color base



IM350
Pantalón multibolsillos
Cargo pant

Talla	XS	S	M	L	XL	XXL
Cintura	86	90	94	98	102	106
Waist	108	108	108	108	108	108
Largo	108	108	108	108	108	108
Length (cm.)						

Color base / Color base



Chaleco acolchado // Quilted vest



SISTEMA DE CODIFICACIÓN CODE SYSTEM

REF XXX XX
TALLA COLOR
SIZE COLOR



IM450

Chaleco acolchado. Quilted vest

Talla	XS	S	M	L	XL	XXL
Pecho	100	108	116	124	132	140
Chest						
Largo	72	72	72	72	75	75
Length						

(cm.)

Color base / Color base

20 40

Personalización Customization

Mínimo 6 unidades por talla. Size: Minimum 6 units per size

IM450

Color base / Color base





BT-60025 XXX

TNT Tejido no tejido de PP Spunbonded de 55 g/m2

Bata de protección de manga larga, esterilizable, cierre con velcro, cuello con bias, puño elástico, unisex, lavable y reutilizable

• Recomendada para la industria alimentaria y como protección para minimizar los riesgos de contaminación cruzada con la propia ropa y con el entorno.

Conforme con el informe de AITEX 2020TM0506

• Resistencia a la penetración del agua

Acorde con los requisitos de la norma EN 13795-1:2019, la muestra analizada cumple con los requisitos para batas quirúrgicas con prestaciones estándar y prestaciones altas en el área poco crítica.

• Resistencia a la penetración microbiana en húmedo.

Atendiendo a los requisitos de la EN 13795-1:2019 Índice barrera = 4,3+-0,2

Apta para Prestaciones standard, área crítica >=2,8 Apta para altas prestaciones, área poco crítica.

• Reutilizable, lavar con jabón neutro > de 60°

• No es un equipo de protección ni un producto sanitario

TNT 55g / m2 PP Spunbonded Non Woven Fabric

Protective gown with long sleeves, sterilizable, velcro closure, bias collar, wrist elastic, unisex, washable and reusable.

• Recommended for the food industry and as protection to minimize the risks of cross contamination with own clothing and with the environment.

Compliant with AITEX 2020TM0506 report

• Resistance to water penetration. In accordance with the requirements of the EN 13795-1: 2019 standard, the analyzed sample complies with the requirements for surgical gowns with standard performance and high performance in the critical area.

• Resistance to wet microbial penetration. In compliance with the requirements of EN 13795-1: 2019 Barrier index = 4.3 + -0.2

Suitable for standard performance, critical area > = 2.8

Suitable for high performance, low area review.

• Reusable, wash with neutral soap > 60°

• It is not a protective equipment or a medical device.

Talla	Ø Contorno	Largo
Size	Ø Contour	Tall
L	128 cm	105 cm
XXL	140 cm	105 cm



MO-70025 XXX

TNT Tejido no tejido de PP Spunbonded de 55 g/m2

Mono de protección de manga larga, esterilizable, cierre con velcro, cuello con bias, puño elástico, unisex, lavable y reutilizable

• Recomendada para la industria alimentaria y como protección para minimizar los riesgos de contaminación cruzada con la propia ropa y con el entorno.

Conforme con el informe de AITEX 2020TM0506

• Resistencia a la penetración del agua

Acorde con los requisitos de la norma EN 13795-1:2019, la muestra analizada cumple con los requisitos para batas quirúrgicas con prestaciones estándar y prestaciones altas en el área poco crítica.

• Resistencia a la penetración microbiana en húmedo.

Atendiendo a los requisitos de la EN 13795-1:2019 Índice barrera = 4,3+-0,2

Apta para Prestaciones standard, área crítica >=2,8 Apta para altas prestaciones, área poco crítica.

• Reutilizable, lavar con jabón neutro > de 60°

• No es un equipo de protección ni un producto sanitario

TNT 55g / m2 PP Spunbonded Non Woven Fabric

Protective coverall with long sleeves, sterilizable, breathable, velcro closure, bias neck, elastic leg and waist, unisex, white, washable and reusable.

• Recommended for the food industry and as protection to minimize the risks of cross contamination with own clothing and with the environment.

Compliant with AITEX 2020TM0506 report

• Resistance to water penetration. In accordance with the requirements of the EN 13795-1: 2019 standard, the analyzed sample complies with the requirements for surgical gowns with standard performance and high performance in the critical area.

• Resistance to wet microbial penetration. In compliance with the requirements of EN 13795-1: 2019 Barrier index = 4.3 + -0.2

Suitable for standard performance, critical area > = 2.8

Suitable for high performance, low area review.

• Reusable, wash with neutral soap > 60°

• It is not a protective equipment or a medical device.

Talla	Ø Contorno	Largo
Size	Ø Contour	Tall
L	130 cm	200 cm
XXL	140 cm	205 cm



Higiene y seguridad alimentaria

Hygiene and food safety

Matainsectos

Fly-insect traps

Secamanos

Hand dryers

Secapelos

Hair dryer

Rejillas urinarios

Urinal screens

Matainsectos Flying insect traps



Análisis de Peligros y Puntos de Control Críticos



Matainsectos eléctricos (domésticos, industriales y con lámina adhesiva)

Diseñamos y fabricamos en nuestros talleres sistemas de control de insectos con más de 25 años de experiencia.

Además de las líneas que presentamos a continuación, tenemos líneas completas en acero inoxidable especiales para la industria alimentaria. De especial interés en los siguientes entornos:

- Industria alimentaria
- Tiendas de alimentación
- Hostelería
- Cocinas
- Instalaciones médicas
- Doméstico

En una concepción moderna del control de insectos voladores, debido a su facilidad para transportar virus y bacterias capaces de contaminar la cadena de alimentos en cualquier punto, pasa a ser pieza fundamental en el cumplimiento del proceso **APPCC** (o sus siglas en inglés **HACCP**), básicamente en los siguientes puntos:

- Identificación de peligros.
- Monitorización de los puntos de control crítico (PCC).
- Verificación del éxito de las acciones correctivas.

Electric trap for flying insects (domestic, industrial and with adhesive sheet)

We design and manufacture electric traps in our workshop for more than 25 years.

In addition to the product line introduced in this Catalogue, we manufacture a complete stainless steel line, ideal for food industry. These traps are specially interesting in the following environments:

- Food industry
- Food stores
- Catering
- Medical facilities
- Domestic

In a modern conception, flying insect control due to its ease of transportation of viruses and bacteria capable of contaminating the food chain at any point, it becomes fundamental part in the fulfillment of the HACCP process basically in the next points:

- Hazard identification.
- Monitoring of critical control points (CCP).
- Verification of the success of the corrective actions.

Matainsectos domésticos Domestic flying insect traps



MAT13P
Matainsectos 13 W. ABS negro
Flying insect trap 13 W. Black ABS



Bandeja insectos extraíble
Removable insect tray



Posibilidad de colgar
It could be suspended

Especificaciones técnicas / Technical specifications

Área de cobertura / Coverage area	☀ 30 m ² - ☾ 60 m ²
Tensión de la rejilla / Grid voltage	1 kv.
Lámpara / Lamp	13 W. lámpara de bajo consumo / 13 W. energy saving lamp

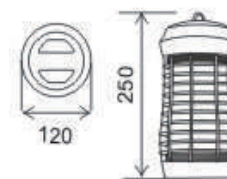

700974
Lámpara de repuesto 13 W. BL E27
Para matainsectos MAT13P
Replacement lamp 13 W. BL E27
For MAT13P

Matainsectos eléctricos industriales

Professional electric flying insect traps



SMPH20
Matainsectos Basic 20 W.
aluminio/ABS
Flying insect trap Basic 20W.
aluminum / ABS

Especificaciones técnicas / Technical specifications:

Área de cobertura / Coverage area: ☀ 60 m² - ☾ 120 m²

Lámpara / Lamp: 2 tubos 10 W. / 2x 10 W, tubes

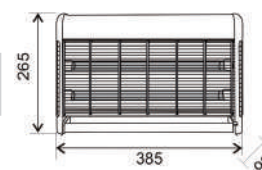

700953
Tubo de repuesto 10 W. BL T8 G13
Para matainsectos SMPH20
Spare tube 10 W. BL T8 G13
For SMPH20



SMPH30
Matainsectos Basic 30 W. aluminio/ABS
Flying insect trap 30W. aluminum / ABS

Especificaciones técnicas / Technical specifications:

Área de cobertura / Coverage area: ☀ 60 m² - ☾ 120 m²

Lámpara / Lamp: 2 Tubos 15 W. / 2 x 15 W, tubes.

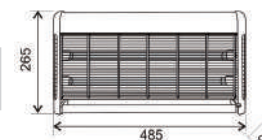

700956
Tubo de repuesto 15 W. BL T8 G13
Para matainsectos SMPH30
Spare tube 15 W. BL T8 G13
For SMPH30



700056 | 10,91 €
Tubo de repuesto 15 W. BL T8 G13 Sylvania
Para matainsectos SMPH30
Spare tube 15 W. BL T8 G13 Sylvania
For SMPH30



SMPH40
Matainsectos Basic 40W. aluminio/ABS
Flying insect trap Basic 40W. aluminum / ABS

Especificaciones técnicas / Technical specifications:

Área de cobertura / Coverage area: ☀ 80 m² - ☾ 140 m²

Lámpara / Lamp: 2 Tubos 20 W / 2 x 20 W, tubes

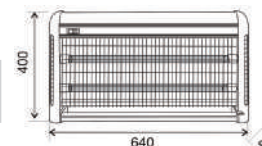

700057
Tubo de repuesto 20 W. BL T12 G13 Sylvania
Para matainsectos SMPH40
Spare tube 20 W. BL T12 G13 Sylvania
For SMPH40



700957
Tubo de repuesto 20 W. BL T8 G13
Para matainsectos SMPH40
Spare tube 20 W. BL T8 G13
For SMPH40

Matainsectos con lámina adhesiva

Flying insect traps with adhesive sheet



EMW20L
Matainsectos 18 W. ABS
 Flying insect trap 18 W. ABS

Especificaciones técnicas / Technical specifications:

Área de cobertura / Coverage area	☀ 40 m ² - ☾ 80 m ²
Lámpara / Lamp	1 lámpara 18 W. bajo consumo / 1 lamp 18 W. energy saving lamp

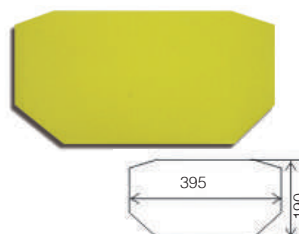
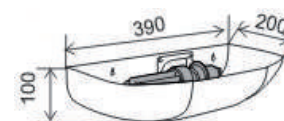

EM696R
Láminas de repuesto
 6 uds para matainsectos EMW20L
Replacement sheets
 6 units for EMW20L



700977
Lámpara de repuesto 18 W. BL CFL E27 2U
 Para matainsectos EMW20L
Replacement lamp 18 W. BL CFL E27 2U
 For EMW20L



EMB020
Matainsectos 18 W. acero epoxi blanco
 Flying insect trap 18 W. white steel epoxy

Especificaciones técnicas / Technical specifications:

Área de cobertura / Coverage area	☀ 40 m ² - ☾ 80 m ²
Lámpara / Lamp	1 lámpara 18 W. bajo consumo / 1 lamp 18 W. energy saving lamp

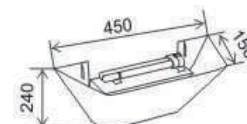

EM396R
Láminas de repuesto
 6 uds para matainsectos EMB020
Replacement sheets
 6 units for EMB020

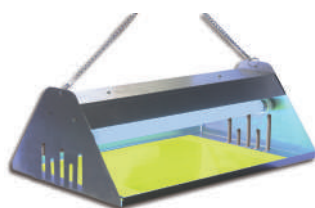
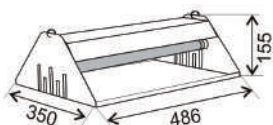

700977
Lámpara de repuesto 18 W. BL CFL E27 2U
 Para matainsectos EMB020
Replacement lamp 18 W. BL CFL E27 2U
 For EMB020

**EM30XI****Matainsectos 30 W. Acero inox. 304****Flying insect trap 30 W. SS 304**

Posibilidad de instalación colgante o mural
Possibility of installation suspended or against the wall

*Especificaciones técnicas / Technical specifications:*

Área de cobertura
/ Coverage area

☀ 60 m² - ☾ 120 m²

Lámpara / Lamp

2 Tubos inastillables 15 W .
/ shatterproof safety lamps 15 W

**EM306R****Láminas de repuesto**6 unids para matainsectos EM30XI
390x300 mm**Spare sheets**6 units for EM30XI
390x300 mm

Fácil colocación del film
Easy placement

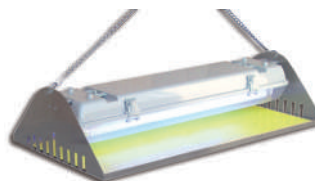
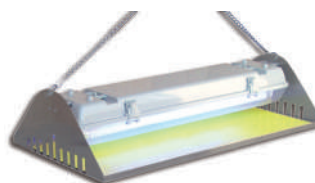
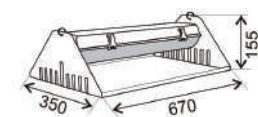
**700055F****Tubo de repuesto inastillable 15 W. BL T8 G13 FEP Sylvania**
Para matainsectos EM30XI**Replacement shatterproof safety lamps 15 W. BL T8 G13 FEP Sylvania**
For EM30XI**700955F****Tubo de repuesto inastillable 15 W. BL T8 G13 FEP FSL**
Para matainsectos EM30XI**Replacement shatterproof safety lamps 15 W. BL T8 G13 FEP FSL**
For EM30XI**EM218S****Matainsectos 40 W. Acero inox. 304****Flying insect trap 40 W. SS 304****EM240S****Matainsectos 80 W. Acero inox. 304****Flying insect trap 80 W. SS 304***Especificaciones técnicas / Technical specifications:*

Área de cobertura
/ Coverage area

☀ 120 m² - ☾ 240 m²

Lámpara / Lamp

2 Tubos 20 W . / 2 x 20 W, tubes.

Especificaciones técnicas / Technical specifications:

Área de cobertura
/ Coverage area

☀ 240 m² - ☾ 480 m²

Lámpara / Lamp

2 Tubos 40 W . / 2 x 40 W, tubes.

**EM406R****Láminas de repuesto**6 unidades para matainsectos EM218S y EM240S
600x280 mm**Spare sheets**6 units for EM218S and EM240S
600x280 mm

Protección contra contacto y penetración de agua y suciedad con pantalla estanca

Protection against contact and penetration of water and dirt with a tight screen

700057



Tubo de repuesto 20 W. BL T12 G13 Sylvania
Para matainsectos EM218S

Spare tube 20 W. BL T12 G13 Sylvania
For EM218S

700957



Tubo de repuesto 20 W. BL T8 G13
Para matainsectos EM218S

Spare tube 20 W. BL T8 G13
For EM218S

700058



Tubo de repuesto 40 W. BL T12 G13 Sylvania
Para matainsectos EM240S

Spare tube 40 W. BL T12 G13 Sylvania
For EM240S

700958



Tubo de repuesto 40 W. BL T8 G13
Para matainsectos EM240S

Spare tube 40 W. BL T8 G13
For EM240S

Dónde colocar los matainsectos eléctricos

Where to place the electrical flying insect traps

Cada instalación es única, por lo tanto, requiere de un estudio individualizado aunque hay unos principios básicos que deberíamos seguir:

- Colocar suficientes unidades para cubrir el área a proteger.
- Instalar lejos de otras fuentes de luz.
- Considerar positivamente las fuentes de calor y corrientes de aire.
- No instalar unidades encima de áreas sensibles, como la zona de preparación de alimentos.
- Tener en cuenta la accesibilidad de la instalación para futuros servicios de mantenimiento.
- Los matainsectos se deberían colocar en puntos de entrada potenciales, para interceptar los insectos antes de que lleguen a zonas sensibles.
- Los aparatos no se deben instalar ni muy altos ni muy bajos en la zona de protección, con una altura óptima de unos 2 metros aproximadamente.

Each installation is unique, therefore requires an individualized study although there are some basic principles that we should follow:

- Place enough units to cover the area to be protected.
- Install away from other sources of light.
- Consider positively heat sources and air currents.
- Do not install units on sensitive areas, such as the food preparation area.
- Take into account the accessibility of the installation for future services of maintenance.
- The flying insect traps should be placed between potential entry points, for Intercept insects before they reach sensitive areas.
- The devices must not be installed too high or too low in the area of protection, with an optimum height of about 2 meters (6'ft 7" in).

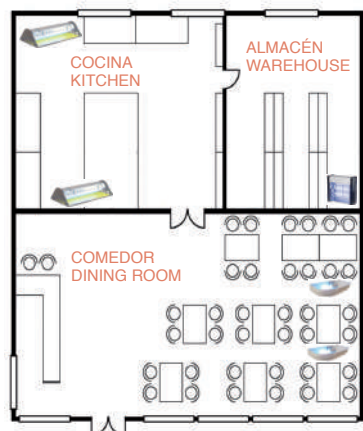

Modelos recomendados por zonas:



Zonas de almacenamiento
SMPH20, SMPH30 y SMPH40, eléctricos industriales



Zonas con clientes:
EMB020, EMW20L y EM30XI, lámina adhesiva (tipo plafón y decorativo).



Zonas de preparación de alimentos:
EM30XI, EM218S y EM240S, lámina adhesiva.

Type of device recommended per zone



Storage areas:
SMPH20, SMPH30 and SMPH40, electrical



Areas with customers
EMB020, EMW20L and EM30XI, adhesive sheet (wall sconce)



Food preparation areas
EM30XI, EM218S and EM240S, ceiling-hung with adhesive sheet



Se trata de un sistema sostenible y económico como la solución para el secado de manos. Los estudios demuestran una reducción del 75% en las emisiones de carbono frente a otros sistemas.

El diseño y la fabricación permiten la reparación y la prolongación de la vida útil y el reciclaje de los componentes, cumpliendo los requisitos de la economía circular.

La elección de secadores electrónicos de manos para lugares públicos ayudara también a reducir los costes operativos, especialmente los de Ultra Alta Velocidad por su reducción en tiempo de secado y su alta eficiencia energética.

Debido a las amenazas potenciales como el Covid-19, tanto la OMS como el propio Ministerio de Sanidad Español, recomiendan tanto los secamanos electrónicos como las toallas de papel y además la industria ha agregado nuevas características a los mismos como los filtros HEPA.

Filtro HEPA (Sistema de retención de partículas volátiles de alta eficiencia)

It is a sustainable and economical system as the solution for hand drying. Studies show a 75% reduction in carbon emission compared to other systems.

The design and manufacture allow the repair and the prolongation of the useful life and the recycling of the components, fulfilling the requirements of the circular economy.

The choice of electronic hand dryers for public places will also help reduce operating costs, especially the Ultra High Speed ones due to their reduction in drying time and their high energy efficiency.

Due to potential threats such as Covid-19, both the WHO and the Spanish Ministry of Health itself, recommend both electronic hand dryers and paper towels, and the industry has also added new features to them, such as HEPA filters.

HEPA Filter (High Efficiency Particle Arrester)



HD098117

Secamanos de alta velocidad

Increíble diseño y función en este Secamanos de Alta Velocidad. Tiempo de secado de 10 segundos, "iStorm" utiliza una cerámica que absorbe el agua del secado, no dejando rastros de agua, ni en el aparato ni en el suelo. La velocidad del aire es regulable, además, con selector de aire natural ó caliente e indicadores led para una mejora en el secado.

High speed hand dryer

Amazing design and function in this high speed hand dryer drying time of 10 seconds, "iStorm" uses a ceramic that absorbs drying water, no leaving traces of water, even in the hand dryer or on the ground. The air speed and temperature are adjustable. Leds indicators are built-in for ease the drying.



Especificaciones técnicas / Technical specifications:

Material / Material	Plástico / Plastic
Potencia / Power	1200W.
Voltaje / Voltage	220/240 ó 125 Opcional / Optional
Tipo de motor / Type motor	1HP,400-750W, 11.000-20.000 RPM. Ajustable / Adjustable
Velocidad de salida del aire caliente / Wind speed	65-100 m/s (234-360 km/h)
Led dual / Dual led	Standby rojo/red, Active azul/blue
Medidas / Measures	32,2 Ancho x 18,5 Hondo x 56 Alto cm 32,2 W x 18,5 D x 56 H cm
Peso Neto / G.W	10,80 Kg.
Peso Bruto / N.W	12,80 Kg.
Resistencia con opción / Resistance with option	ON/OFF. 300-450 W, ajustable / Adjustable



HD095109

Secamanos de alta velocidad

Secamanos Óptico de Acero Inox satinado

Ultra-alta Velocidad

Representa un ahorro del 95% respecto de las toallas de papel.

High speed hand dryer

Satin stainless steel electronic sensor

Ultra-high Speed

It represents a saving of 95% respect of the paper towels.

Personalizable Customizable



Especificaciones técnicas: // Technical specifications:

Material / Material	Acero inox satinado / Satin SS
Potencia / Power	1600W.
Voltaje / Voltage	220/240 V ó 125 Opcional / Optional
Tipo de motor / Motor type	15/16HP, 700W, 15.000-18.000 RPM. Ajustable / Adjustable
Velocidad de salida del aire / Wind speed	65-100 m/s (234-360 km/h)
Medidas / Measures	23,5 Ancho x 17,8 Hondo x 28,6 Alto cm / 23,5 W x 17,8 D x 28,6 H cm
Peso Neto / G.W.	6 kg..
Peso Bruto / N.W	6,80 kg..



HD094117

Secamanos de alta velocidad compacto

Secamanos Óptico de Acero Inox, Blanco

Ultra-alta Velocidad

Representa un ahorro del 97% respecto de las toallas de papel.

Compact high speed hand dryer

White electronic sensor stainless steel

Ultra-high Speed

It represents a saving of 97% compared to paper towels

Especificaciones técnicas: // Technical specifications:

Material / Material	Acero inox, blanco / SS white
Potencia / Power	1000W.
Voltaje / Voltage	220/240 ó 125 Opcional / Optional
Tipo de motor / Motor type	3/4HP, 500W, 29.000 RPM
Velocidad de salida del aire / Wind speed	90 m/s (324 km/h)
Medidas / Measures	24,1 Ancho x 14 Hondo x 16,5 Alto cm / 24,1 W x 14 D x 16,5 H cm
Peso Neto / G.W	3,6 kg
Peso Bruto / N.W	4,08 Kg.

**K2A****Secamanos Motor sin escobillas**

Brushless motor

K2B**Motor con escobillas**

Motor with brushes

Secamanos de ultra-alta velocidad

Cuenta con dos salidas de aire con las que se consigue un secado en poco tiempo y uniforme.

Sistema inteligente de control de la temperatura del caudal. El calor del aire se ajusta automáticamente a la temperatura ambiente, anulándose cuando ésta es superior a 25° y restableciéndose cuando desciende ésta, con el consiguiente ahorro de energía.

Unos sensores localizados estratégicamente activan de inmediato el funcionamiento del secamanos desconectándolo cuando las manos se retiran después del secado.

Este secamanos está diseñado con un motor DC (compacto) sin escobillas para un uso de 1.000 servicios diarios con un eficiente rendimiento.

Equipado con Filtro HEPA: sistema de reducción de contaminación bacteriana.

Ultra-high speed hand dryers

It comes with two air vents with which a short and uniform drying is achieved.

Intelligent system to control the flow temperature. The heat of the air automatically adjusts to the ambient temperature, canceling when it is higher than 25° and restoring itself when it descends, with the consequent saving of energy.

Strategically located sensors immediately activate the operation of the hand dryer by disconnecting it when the hands are removed after drying.

This hand dryer is designed with a DC (compact) brushless motor for a use of 1,000 daily services with an efficient performance.

Equipped with HEPA filter: bacterial contamination reduction system

Especificaciones técnicas: // Technical specifications:

Material / Material	ABS Blanco / ABS White
Potencia / Power	1900 W
Voltaje / Voltage	220/240 V
Velocidad de salida del aire / Wind speed	85-95 m/s (302-342 km/h.)
Medidas / Measures	30 Ancho x 22 Hondo x 68,7 Alto cm. / 30 W x 22 D x 68,7 H cm
Peso Neto / G.W	11 kg
Peso Bruto / N.W	12 kg

**K2015****Secamanos de ultra velocidad**

Con doble salida de cortina de aire. Secado de las manos en 10 segundos. Distancia accionamiento: 12 +/- 3 cm. Funciona con detector de proximidad. Equipado con filtro HEPA.

Ultra-speed hand dryer

With double air curtain outlet. Drying of hands in 10 seconds. It works with proximity detector, 12 +/- 3 cm. Equipped with HEPA filter

Especificaciones técnicas: // Technical specifications:

Material / Material	Acero inox 304 cepillado / SS 304 brushed
Potencia / Power	2000W
Voltaje / Voltage	220 - 240 V / 50 - 60 HZ
Velocidad de salida del aire / Wind speed	100 m/s (360 km/h)
Medidas / Measures	20 Ancho x 31 Hondo x 32 Alto cm. / 20 W x 31 D x 32 H cm
Peso Neto / G.W	6 kg
Peso Bruto / N.W	6,70 kg



K2013

Secamanos electrónico alta velocidad

Secado de las manos en 07 - 12 segundos.
Sensor electrónico, funciona con detector de proximidad.
Protección antivandálica.
Equipado con filtro HEPA.

High speed electric hand dryer

Drying of hands in 07 - 12 seconds.
Electronic sensor, works with proximity detector.
Anti-vandalism protection.
Equipped with HEPA filter.

Especificaciones técnicas: // Technical specifications:

Material / Material	Acero inox 304 cepillado / SS 304 brushed
Potencia / Power	625 / 1.250W
Voltaje / Voltage	220 - 240 V / 50 Hz
Velocidad de salida del aire / Wind speed	90 m/s (324 km/h)
Medidas / Measures	26,2 Ancho x 17,4 Hondo x 24 Alto cm. / 26,2 W x 17,4 D x 24 H cm
Peso Neto / G.W	4,5 kg
Peso Bruto / N.W	5 kg



K2013B

Secamanos electrónico alta velocidad

Secado de las manos en 07 - 12 segundos.
Sensor electrónico, funciona con detector de proximidad.
Protección antivandálica.
Equipado con filtro HEPA.

High speed electric hand dryer

Drying of hands in 07 - 12 seconds.
Electronic sensor, works with proximity detector.
Anti-vandalism protection.
Equipped with HEPA filter.

Especificaciones técnicas: // Technical specifications:

Material / Material	ABS Blanco / ABS White
Potencia / Power	625 / 1.250W
Voltaje / Voltage	220 - 240 V / 50 Hz
Velocidad de salida del aire / Wind speed	90 m/s (324 km/h)
Medidas / Measures	26,2 Ancho x 17,4 Hondo x 24 Alto cm. / 26,2 W x 17,4 D x 24 H cm
Peso Neto / G.W	4 kg
Peso Bruto / N.W	4,5 kg



K2016

Secamanos de alta velocidad ADA, ultra fino

Cumple con normativa ADA para personas con discapacidad.
Detección automática.
Secado de las manos en 10 segundos.
Ultra fino y minimalista

ADA high-speed hand dryer, ultra thin

Meets ADA regulations for people with disabilities.
Automatic detection.
Drying of hands in 10 seconds.
Ultra thin and minimalist.

Especificaciones técnicas: // Technical specifications:

Material / Material	Acero inox 304 cepillado / SS 304 Brushed
Potencia / Power	1000W
Voltaje / Voltage	220 V / 50 Hz
Velocidad de salida del aire / Wind speed	90 m/s (324 km/h)
Medidas / Measures	30 Ancho x 10 Hondo x 32 Alto cm. / 30 W x 10 D x 32 H cm
Peso Neto / G.W	3,3 kg
Peso Bruto / N.W	3,75 kg



K2017

Secamanos de alta velocidad

Detección automática
Secado de las manos en 10-12 segundos
Protección antivandálica.

High speed hand dryer

Automatic detection.
Drying of hands in 10-12 seconds.
Anti-vandalism protection.

Especificaciones técnicas: // Technical specifications:

Material / Material	Acero inox 304 cepillado / SS 304 brushed
Potencia / Power	1800W
Voltaje / Voltage	220 V / 50 Hz
Velocidad de salida del aire / Wind speed	90 m/s (324 km/h)
Medidas / Measures	29,5 Ancho x 17,1 Hondo x 32,5 Alto cm. / 29,5 W x 17,1 D x 32,5 H cm
Peso Neto / G.W	20 kg
Peso Bruto / N.W	22 kg

Secamanos convencionales // Conventional Hand dryer



K1006E

Secamanos ABS

Sensor electrónico, funciona con detector de proximidad.
Distancia accionamiento: 12 +/- 3 cm.

ABS hand dryer

Electronic sensor.
Works with proximity detector, 12 +/- 3 cm

Especificaciones técnicas: // Technical specifications:

Material / Material	ABS Blanco / ABS White
Potencia / Power	1500W
Voltaje / Voltage	220 - 240 V / 50-60 Hz
Velocidad de salida del aire / Wind speed	20-30 m/s (72-108 km/h)
Medidas / Measures	17,2 Ancho x 14,2 Hondo x 19,2 Alto cm. / 17,2 W x 14,2 D x 19,2 H cm.
Peso Neto / G.W	2,6 kg
Peso Bruto / N.W	2,9 kg



K2502A

Secamanos Antivandálico

Sensor electrónico, funciona con detector de proximidad.
Tiempo de secado: 10-15 segundos

Stainless steel Hand dryer

Electronic sensor, works with proximity detector.
Drying time: 10-15 seconds.

Especificaciones técnicas: // Technical specifications:

Material / Material	Acero inox 304 cepillado / SS 304 Brushed
Potencia / Power	2300W
Voltaje / Voltage	220 V / 50 Hz
Velocidad de salida del aire / Wind speed	30 m/s (108 km/h)
Medidas / Measures	29,5 Ancho x 26,5 Hondo x 25 Alto cm. / 29,5 W x 26,5 D x 25 H cm
Peso Neto / G.W	5 kg
Peso Bruto / N.W	5,5 kg

Secapelos // Hair dryer



K3515

Secador de cabello con soporte Hair dryer with support

Color / Color Blanco/White
Potencia / Power 1200W

Rejillas para urinario // *Urinal screen*



Las rejillas de urinario están fabricadas con materiales ecológicos y biodegradables y cumplen las siguientes funciones:

- Evitar que se obstruya el desagüe como consecuencia de residuos tales como chicles, colillas, etc...
- Perfumar y neutralizar olores provocados por las sales de la orina y su descomposición.
- Anti salpicaduras, evitando con su diseño el retorno de la orina.
- Además, en muchos casos liberan enzimas con un añadido efecto antical, mejorando y potenciando su limpieza a través de microorganismos "buenos", capaces de deshacer la materia orgánica del urinario, evitando su descomposición y reduciendo la periodicidad de su limpieza.

Urinary screens are made of eco-friendly and biodegradable materials and perform the following functions:

- Prevent the drain from being blocked as a result of residue such as gum, cigarette's ends, etc...
- Perfume and neutralize odors caused by urine salts and decomposition.
- Anti splashing, avoiding with its design the return of urine.
- In addition, in many cases they release enzymes with an added anti-lime effect, improving and enhancing their cleaning through "good" microorganisms, capable of undoing the organic matter of the urinal, avoiding its decomposition and reducing the periodicity of its cleaning.

Rejillas de vinilo para urinarios // *Vinyl urinal screens.*

- Fragancia potente de liberación duradera.
- Diseñado para no permitir la obturación de tuberías.
- Anti-salpicaduras.
- Protege y ambienta desde el primer momento.
- Fabricado con materiales ecológicos y biodegradables.
- Cumple con la normativa siguiente:

- Powerful long-lasting release fragrance.
- Designed to avoid the block of the pipes.
- Anti-splash.
- Protects and gives flavour to the bathroom from the very first moment.
- Manufactured with ecological and biodegradable materials.
- Complies with the following regulations:



IMU204

Rejilla urinario de vinilo con aroma a fresa

Envasado con bolsa individualmente.
16.5 x 16.5 cm
12 uds por caja interior
6 cajas interiores por caja maestra
28 x 23 x 22 cm
140 cajas maestras por pallet

Vinyl urinal screen, with strawberry scent

1 pc per bag. Size: 16.5 x 16.5 cm
12 pcs per box
6 boxes per master carton 28 x 23 x 22 cm
140 master cartons per pallet

Rejillas para urinario con pastilla enzimática de 85 gramos

// *Urinal screen with 3 oz enzymatic block*

- Fragancia potente de liberación duradera.
- Liberación de enzimas para la limpieza del urinario y su drenaje.
- Diseñado para no permitir la obturación de tuberías.
- Anti-salpicaduras.
- Limpia y ambienta desde el primer momento.
- Fabricado con materiales ecológicos y biodegradables.
- Cumple con la normativa siguiente:

- Powerful long-lasting release fragrance.
- Release of enzymes for cleaning the urinal and its drainage.
- Designed to avoid the block of the pipes.
- Anti-splash.
- Clean and gives aroma to the bathroom from the very first moment.
- Manufactured with ecological and biodegradable materials.
- Complies with the following regulations:

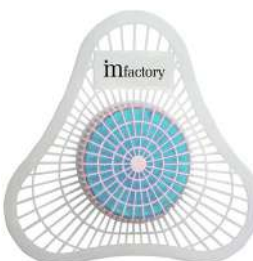

IMU301

Rejilla urinario con pastilla enzimática de 85 gramos con aroma floral

Envasado con bolsa individualmente.
16 x 17.5 cm
12 uds por caja interior
6 cajas interiores por caja maestra
54 x 37 x 28 cm
42 cajas maestras por pallet

Urinal screen with 3 oz enzymatic block floral scent

1pc per bag. Size: 16 x 17.5 cm
12 pcs per box
6w boxes per master carton 54 x 37 x 28 cm
42 master cartons per pallet

Rejillas de gel para urinario, enzimáticas

// Gel and enzymatic urinal screen

- Fragancia potente de liberación duradera.
- Liberación de enzimas para la limpieza del urinario y su drenaje.
- Diseñado para no permitir la obturación de tuberías.
- Translúcido.
- Anti-salpicaduras.
- Limpia y ambienta desde el primer momento.
- Fabricado con materiales ecológicos y biodegradables.
- Cumple con la normativa siguiente:

- Powerful long-lasting release fragrance.
- Release of enzymes for cleaning the urinal and its drainage.
- Designed to avoid the block of the pipes. Translucent.
- Anti-splash.
- Clean and gives flavour to the bathroom from the very first moment.
- Manufactured with ecological and biodegradable materials.
- Complies with the following regulations:



IMU107

Rejilla de gel para urinario, enzimática con aroma a melón

Envasado con bolsa individualmente.
16.5 x 16.5 cm
10 uds por caja interior
10 cajas interiores por caja maestra
41 x 37 x 23 cm
63 cajas maestras por pallet

Enzymatic gel urinal screen, with melon scent

1 pc per bag. Size: 16.5 x 16.5 cm
10 pcs per box
10 boxes per master carton 41 x 37 x 23 cm
63 master cartons per pallet



IMU106C

Rejilla de gel para urinario, enzimática con aroma a manzana/canela

Envasado con bolsa individualmente.
16.5 x 16.5 cm
10 uds por caja interior
10 cajas interiores por caja maestra
41 x 37 x 23 cm
63 cajas maestras por pallet

Enzymatic gel urinal screen, with apple/cinnamon scent

1 pc per bag. Size: 16.5 x 16.5 cm
10 pcs per box
10 boxes per master carton 41 x 37 x 23 cm
63 master cartons per pallet



IMU104

Rejilla de gel para urinario, enzimática con aroma a mango

Envasado con bolsa individualmente.
16.5 x 16.5 cm
10 uds por caja interior
10 cajas interiores por caja maestra
41 x 37 x 23 cm
63 cajas maestras por pallet

Enzymatic gel urinal screen, with mango scent

1 pc per bag. Size: 16.5 x 16.5 cm
10 pcs per box
10 boxes per master carton 41 x 37 x 23 cm
63 master cartons per pallet

Rejillas de gel para urinario, enzimáticas a doble cara

// *Gel and enzymatic double sides urinal screen.*

- Fragancia potente de liberación duradera.
 - Liberación de enzimas para la limpieza del urinario y su drenaje.
 - Diseñado para no permitir la obturación de tuberías.
- Translúcido.
- Función anti-salpicadura por ambos lados
 - Limpia y ambienta desde el primer momento.
 - Fabricado con materiales ecológicos y biodegradables.
 - Cumple con la normativa siguiente:

- Powerful long-lasting release fragrance.
- Release of enzymes for cleaning the urinal and its drainage.
- Designed to avoid the block of the pipes. Translucent.
- Double sides anti-splash.
- Clean and gives flavour to the bathroom from the very first moment.
- Manufactured with ecological and biodegradable materials.
- Complies with the following regulations:

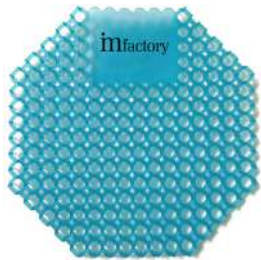

IMU701

Rejilla de gel para urinario, enzimática a doble cara con aroma a océano fresco

Envasado con bolsa individualmente.
16.5 x 16.5 cm
5 uds por caja interior
10 cajas interiores por caja maestra
41 x 37 x 23 cm
63 cajas maestras por pallet

Enzymatic gel urinal screen, double sides with fresh ocean scent

1 pc per bag. Size: 16.5 x 16.5 cm
5 pcs per box
10 boxes per master carton 41 x 37 x 23 cm
63 master cartons per pallet



IMU704

Rejilla de gel para urinario, enzimática a doble cara con aroma a pomelo

Envasado con bolsa individualmente.
16.5 x 16.5 cm
5 uds por caja interior
10 cajas interiores por caja maestra
41 x 37 x 23 cm
63 cajas maestras por pallet

Enzymatic gel urinal screen, double sides with grapefruit scent

1 pc per bag. Size: 16.5 x 16.5 cm
5 pcs per box
10 boxes per master carton 41 x 37 x 23 cm
63 master cartons per pallet



IMU703

Rejilla de gel para urinario, enzimática a doble cara con aroma a pino

Envasado con bolsa individualmente.
16.5 x 16.5 cm
5 uds por caja interior
10 cajas interiores por caja maestra
41 x 37 x 23 cm
63 cajas maestras por pallet

Enzymatic gel urinal screen, double sides with pine scent

1 pc per bag. Size: 16.5 x 16.5 cm
5 pcs per box
10 boxes per master carton 41 x 37 x 23 cm
63 master cartons per pallet